

ROBIT® TOP HAMMER PRODUCT CATALOGUE

The Competitive Offering in High Quality Drilling Consumables

- Drifting and tunneling
- Long hole drilling
- Reaming equipment
- Surface drilling
- Shank adapters
- Auxiliary tools



Robit
FURTHER. FASTER.



ROBIT® TOP HAMMER PRODUCT CATALOGUE

Copyright © 2022, Robit Plc

All rights reserved. No part of this catalogue may be reproduced or transmitted in any form or by any means, electronic or mechanical, including photocopying, recording, or by any information storage and retrieval system, without written permission from the publisher.

Trademarks

Robit is a trademark of Robit Plc

Publisher

Robit Plc

www.robitgroup.com

Printed: August 2022

Robit reserves all rights to any changes in the products and the specifications without prior notice.

CONTENTS



ROBIT IN BRIEF	4
PRODUCT LINES	6
TOP HAMMER APPLICATIONS	7
ROBIT TOP HAMMER OFFERING	8
ROBIT® RBIT™ SERIES	10
ROBIT® RBIT™ MANUFACTURING	12
ROBIT® RBIT™ SERIES – NEW INNOVATIONS	13
ROBIT® RBIT™ AUGMENTED REALITY “AR” APPLICATION	14
ROBIT® RBIT™ DESCRIPTIONS	16
ROBIT® RBIT™ BIT FEATURES	17
ROBIT® RBIT™ SELECTION GUIDE	18
ROBIT® RBIT™ ROD & SHANK MANUFACTURING	20
ROBIT® ROD DESCRIPTIONS	21
ROBIT® DRILL RODS	22
ROBIT® SHANK ADAPTERS	23
DRIFTING AND TUNNELING	24
LONG HOLE DRILLING	40
REAMING EQUIPMENT	54
SURFACE DRILLING	58
SHANK ADAPTERS	76
AUXILIARY TOOLS	102

“Rbit™ Series – The New Standard for High Quality Top Hammer Drilling from Robit.”



ROBIT IN BRIEF

The competitive offering in drilling consumables

Robit Plc is a strongly internationalized growth company selling and servicing drilling consumables. The company's products are favored by global customers for applications in mining, surface drilling and foundation, underground construction, and well drilling. Drilling consumables are Robit's one and only focus.

The company's offering is divided into three product and service ranges: Top Hammer, Down the Hole, and Geotechnical. The products are known for their high quality, excellent drilling results, and performance achieved by the latest technology.

Robit has its own sales and service points in eight countries, as well as an active dealership network, through which it sells to more than 100 countries. The manufacturing units are located in Finland, South Korea, Australia and UK, which guarantee short and precise deliveries.

Robit is listed in Nasdaq Helsinki Ltd's marketplace with trading code ROBIT.

For more information, see www.robgroup.com





Top Hammer Business

Robit Top Hammer business line covers all applications in construction, quarrying and mining, as well as blasting and forepoling, from the softest to the hardest of rock conditions. Underground construction is one of the most important customer segments for Robit bits, and applications such as drifting and bolt hole drilling are well catered for, as well as RoX top hammer casing systems for tunneling support. Robit's quality has been approved worldwide by major mining and quarrying customers. The selection is wide and encompasses products, such as: drifting and tunneling bits, reaming equipment, bench and production drilling bits, rods, shanks, couplings, and auxiliary tools, such as button bit adapters.

We offer You:

- *The highest quality in drilling consumables – Our focus is 100% in drilling consumables.*
- *Excellent drilling results and performance – We have references worldwide.*
- *We emphasize short and precise deliveries from 4 factories – Additionally, Robit has comprehensive storages on every continent.*

Robit is following together with its key customers the development steps of more powerful hydraulic drifters. Robit is modelling and simulating the dynamic forces and stresses, and innovates new solutions to meet the drillers' needs for the best performance, efficiency and lifetime.

Down the Hole Business

The Down the Hole business line covers all operations related to the down the hole drilling method. The main product categories consist of DTH hammers, DTH bits and DTH tubes. The selection is competitive and encompasses top quality products for all your drill & blast applications.

Geotechnical Business

Robit's Geotechnical business line focuses on geotechnical applications, particularly anchoring, micropiling and underpinning, piling, and well drilling. Geotechnical applications are most commonly related to drilling done before or as a part of a construction process. Our selection contains a wide variety of specialized DTH hammers, drill bits and ring bits, as well as advanced casing systems for all your needs.

More info about Robit's products and digital catalogues at company's website: www.robitgroup.com.

TOP HAMMER APPLICATIONS

Robit
TOP HAMMER



Robit

Competitive offering in Top Hammer drilling consumables



- **Efficient Button Bits** – made with 100% recyclable steel. Computational fluid dynamics (CFD) simulations used in pre-testing of flushing properties. Developed in co-operation with customer's field tests.



- **Reliable Reaming Equipment** – wide range of modern Rbit™ Dome Reamers and conventional adapters with reamers.



- **Strong Drill Steel** – Rods, Top Hammer Drill Tubes, Shanks and Couplings. Manufactured in one of the world's most modern factories in South Korea with the latest technology. Shanks for all common drifter brands. Wide range of rod types and lengths.



Proven quality – manufactured with automated production lines

- Sustainable, 100% recyclable steel and over half of it is carbon neutral
- Excellent and optimized bits for abrasive and soft rock formations
- High penetration rate in all rock formations

Reliable partner

*Competitive offering in drilling consumables – Proven quality – Customization for project needs
– Drill master service – Solving drilling challenges and problems – Experience – References*



New Robit Superior Rbit™ Button Bit Series – Functional Design for Professionals

Our customers already know the great quality of our Top Hammer Button Bits. However, we took up the challenge of making our bits even better. All our button bits have been manufactured with recyclable 100% steel. Consistent top quality is guaranteed by fully automated production lines. Rbit™ are finalized with water-based paint. As a result, we have created the Rbit™.

With the Rbit™, our commitment is to help our customers to reduce the total drilling costs by **achieving faster rate of penetration and the lowest cost-per-meter**. The Rbit™ features:

- An optimized button layout configuration of the Flat Face, to ensure **maximized rock contact and energy transmission**.
- A new transition face was developed in both Flat Face and Drop Center to **improve the transfer of percussion energy into the rock**.
- Enhanced flushing design, now available in our Flat Face and Drop Center models, delivering even **faster rate of penetration**.
- Redesigned wider retrac grooves allow more space, delivering a **better flow for the cuttings**.
- **Heavy Duty models** are now **available** in both Flat Face and Drop Center.

All of our new high-quality Rbit™ drill bits have been designed with state of the art Computer Fluid Dynamics (CFD) simulation. Moreover, field tests globally have demonstrated clear evidence of a superior drilling performance, which our technical simulation had already guaranteed (refer chart on the right). Our partner drillers were happy with the excellent performance and noted better flushing and longer grinding intervals with the new Rbit™ drill bits. Robit products are developed in the challenging rock conditions of Scandinavia and have a proven record globally. With Robit's new Rbit™, we have found yet another way to deliver excellence to our customers worldwide.

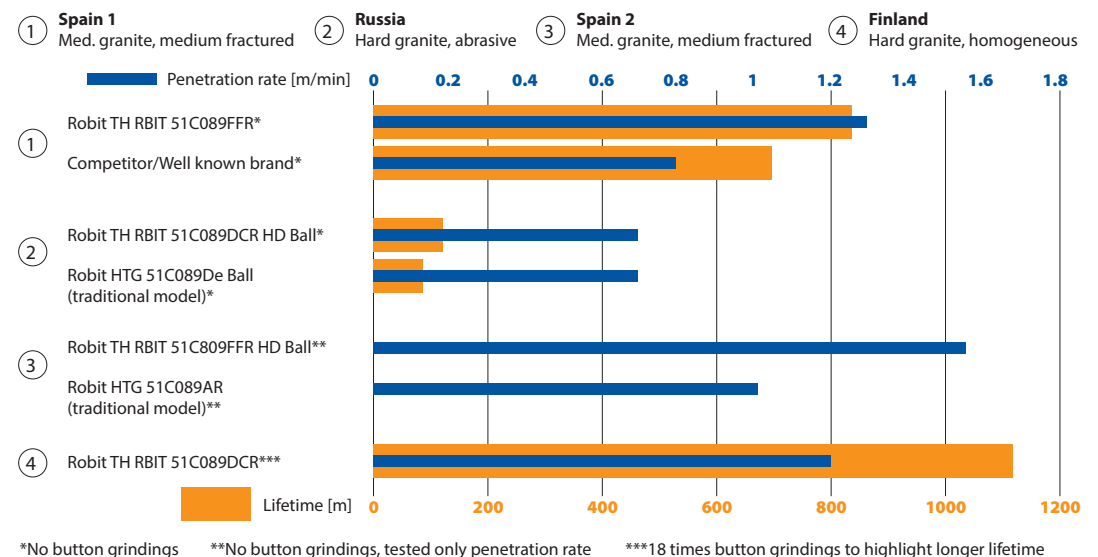

*Summarizing all the essential drilling features, we are going deeper with more speed and force, driving the development of the drilling consumables industry. As an established global company, we continuously need to reinvent ourselves. Across the globe, our cases are more versatile, our knowledge base wider, our questions and tools for finding answers smarter. We fight hard every day to be the strongest and smartest when it comes to the space between drill and rock so that we deliver only the best to our valued customers. That is the true spirit of **Robit® Rbit™**.*





ROBIT® RBIT™ MANUFACTURING

Premium Steel

Over half of the steel used in Robit Rbit™ button bits are manufactured from carbon neutral steel.



1

Automated Production Lines

Fully automated production lines with the latest technology guarantee consistent top quality.



2

Quality Inspection

Each Rbit™ button bit will be inspected during the manufacturing process.

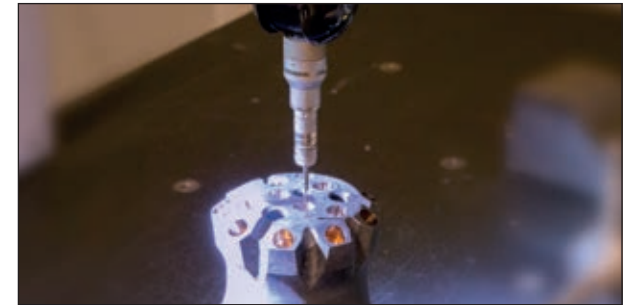

3

4



Buttonging

Robit buttonging cells are the latest state-of-the-art robotized units – optimized insertion secured.



Automated Painting Line

Robit Rbit™ button bits are painted with water-based paint.

5

6



Scheduled Delivery

All of the Robit products will be delivered for the customers precisely.

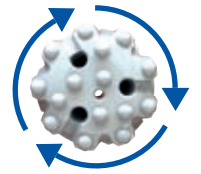

New transition face ensuring better energy transfer

- Transition face with rounded edges enables better flushing design and optimized button layout ⇒ New functionality of the bit



Optimized button layout maximizing rock contact

- Smart button configuration ⇒ Optimized rock breaking dynamics



Wider flushing grooves allowing better flow of cuttings

- Improved flushing ⇒ Maximized flushing efficiency



Optimized placement of flushing holes allowing better flow of cuttings

- Improved flushing ⇒ Maximized flushing efficiency





ROBIT® RBIT™ AUGMENTED REALITY “AR” APPLICATION

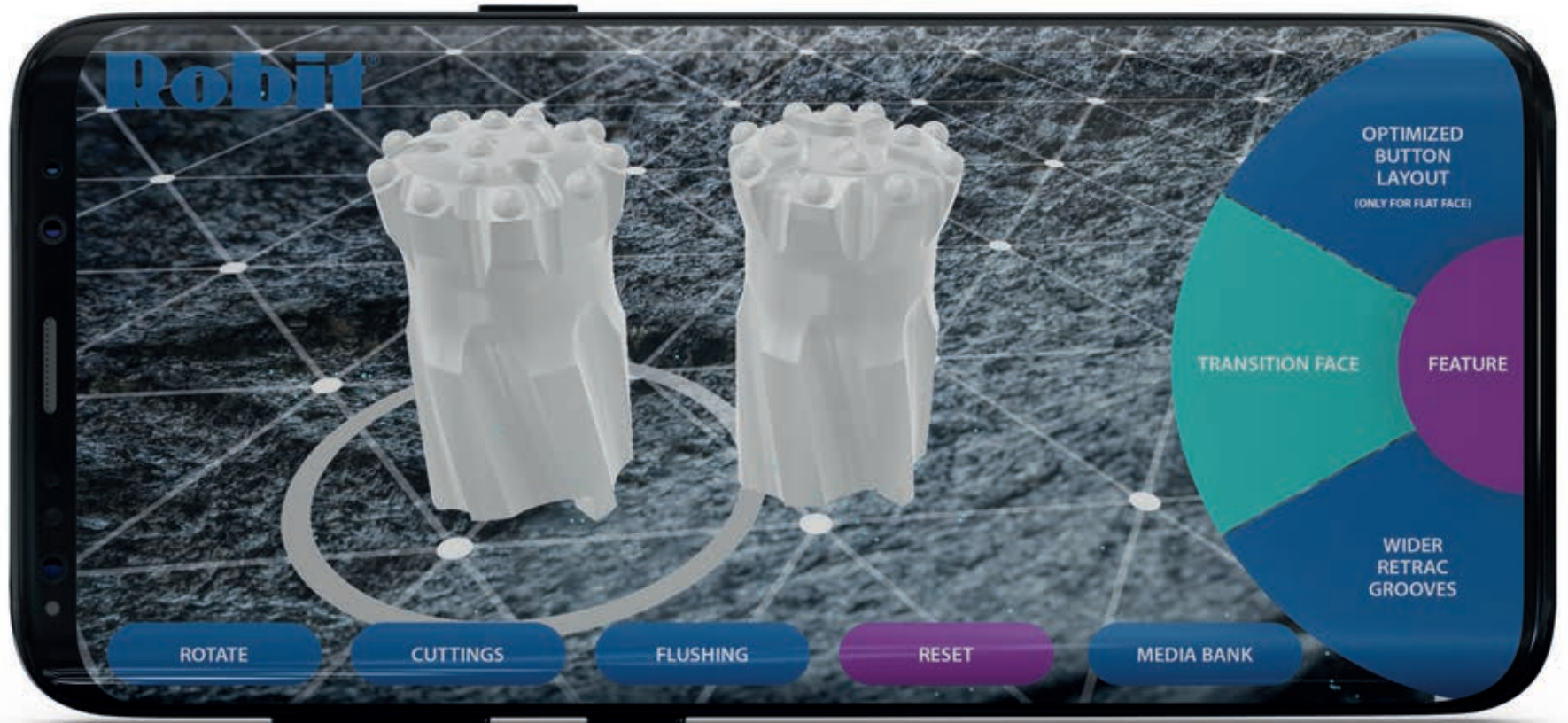

Robit® Rbit™ AR Application

Please download Robit® Rbit™ AR Application for your smartphone to present the new series for your customer. You can demonstrate new features without carrying bits in your pockets. Applications will be found with “Robit Rbit” title:



iOS



Android





ROBIT® RBIT™ DESCRIPTIONS

Robit Premium steel

All of the Robit button bits are manufactured of 100% recyclable steel. Over half of the steel used in Robit button bits is carbon neutral. Robit steel grade gives even more uniform properties and improved fatigue strength, which is crucial in rock drilling process.

- Specially designed for Robit
- Better fatigue and wear resistance
- 100% recyclable
- Over 50% of steel used is carbon neutral

Robit Rbit™ button bit description

Best Sellers* (high availability)

All of our button bits are designed and manufactured with the highest standards of quality. Now you can also easily find the preferred button bits from drillers worldwide. You can find those throughout the catalogue as the part number is highlighted in blue with a star.

Example: TH RBIT 45C089DCR HD SB1 (2000114*)

TH RBIT	45	C	089	DC	R	HD	SB	1
Product Group	Thread Size [mm]	Thread Type	Bit Diameter Size [mm]	Face Type	Body Type	Version	Carbide Profile	Carbide Grade
TH RBIT	25-68	R	032-180	A = Basic model	() = Standard	HD = Heavy Duty	H = Hemispherical	1 = Standard Grade
		RR		M = Maximized flushing	R = Retrac		SB = Semi-Ballistic	
		C		S = Speed drilling				
		CT		FF = Flat Face				
		RG		DC = Drop Center				
				DOME				

*Best Seller

Robust buttons

All the products are available with semi-ballistic or hemispherical buttons.



Optimized body types





Rbit™ series specifications

Flushing grooves in face and on side

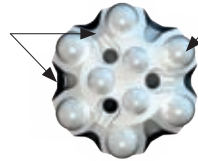

High quality tungsten carbides

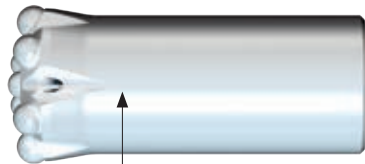

Wear resistant heat treated steel body made from high quality Scandinavian steel

Flushing grooves in face and on side

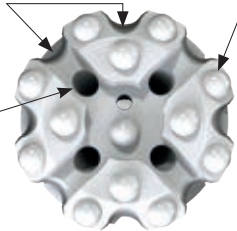

High quality tungsten carbides

Improved face flushing hole

New optimal retrac body

Wider retrac grooves



R - Retrac teeth

Wear resistant heat treated steel body made from high quality Scandinavian steel

Rbit™ S-model radical updates

Optimized flushing grooves & holes and button layout

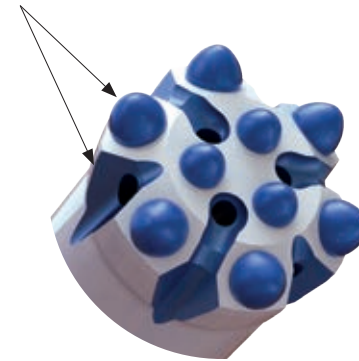

Revolutionary transition face (FF & DC models)

Transition face with rounded edges enables optimized button layout and new functional features to the bit.

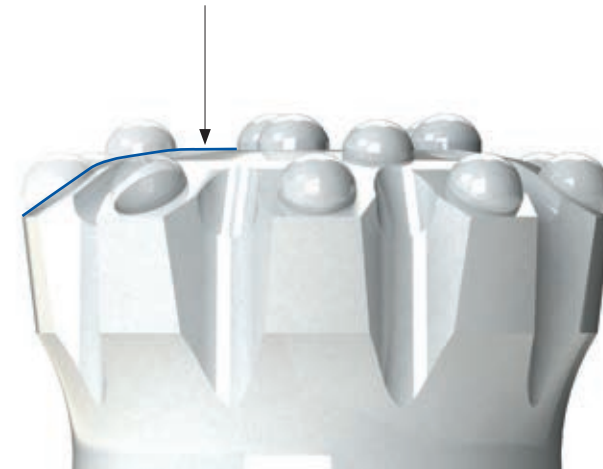



ROBIT® RBIT™ BIT SELECTION GUIDE

Rbit™ series specifications

Computational Fluid Dynamics (CFD) simulation images show the efficient flushing properties of new Rbit™ series.

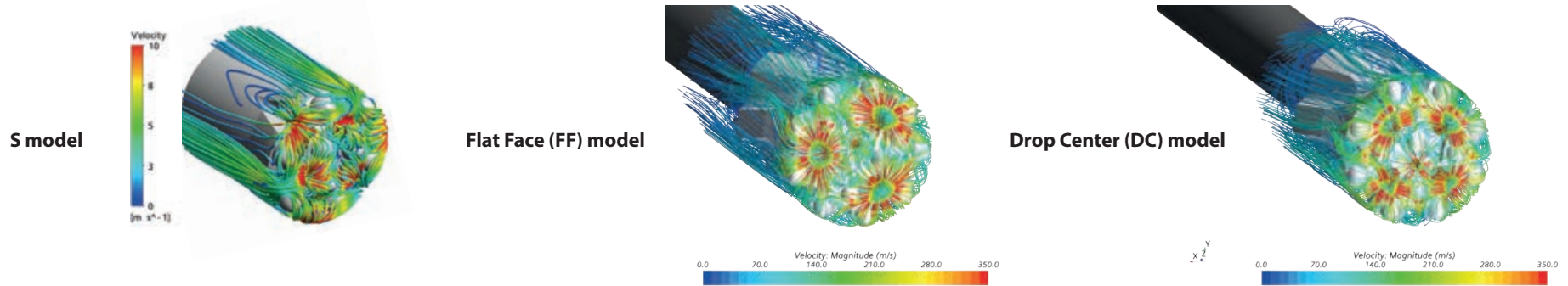

Advanced face types

- A = Basic model for medium and hard rock drilling
- M = Maximized flushing properties for soft and medium hard rock
- S = Speed drilling model for various conditions
- S HD = Speed drilling Heavy Duty model for various conditions

- FF = Flat Face for medium and hard rock conditions
- FF HD = Flat Face Heavy Duty model for more abrasive conditions
- DC = Drop Center model for straighter holes with maximum flushing properties. (For soft and medium hard rock for speed drilling)
- DC HD = Drop Center Heavy Duty model for more abrasive conditions

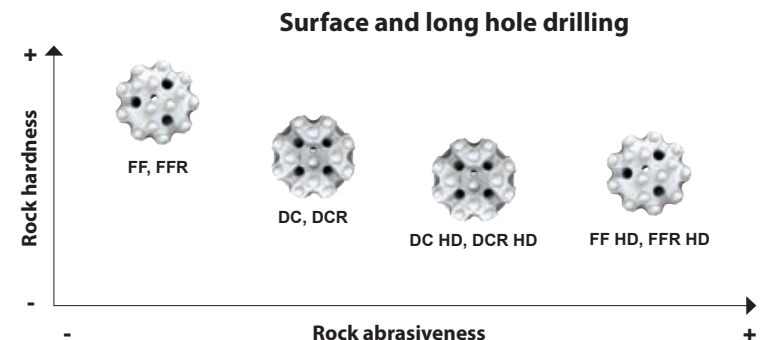
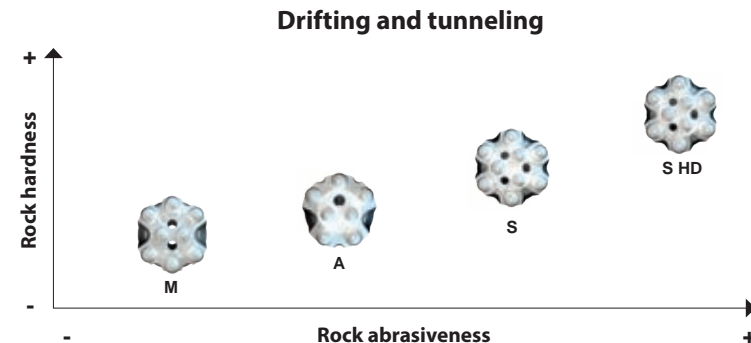

ROBIT® RBIT™ BIT SELECTION GUIDE



Selecting face type

Drifting and tunneling

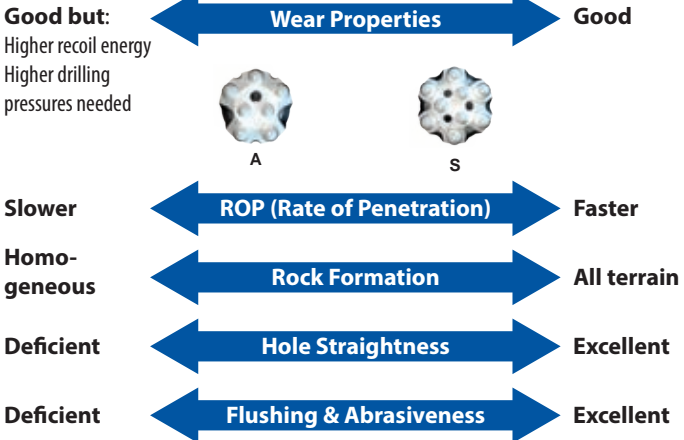

Surface and long hole drilling

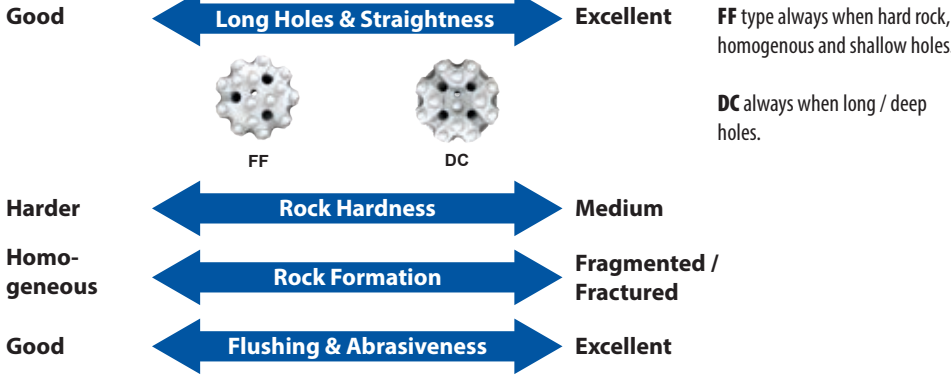

Selecting body type

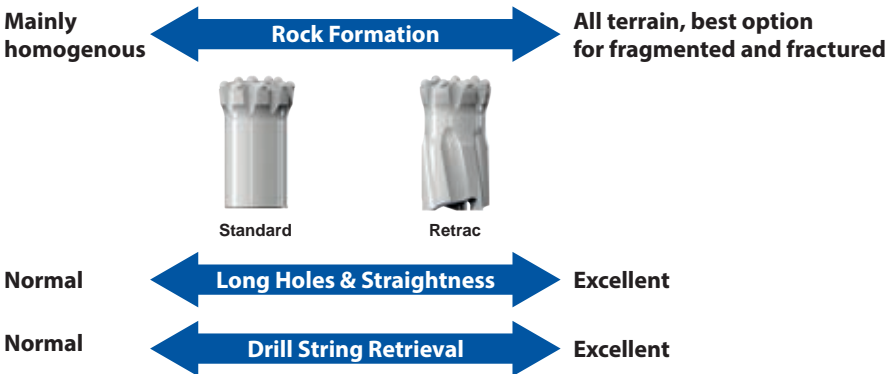

Selecting carbide shape: drilling speed versus rock hardness

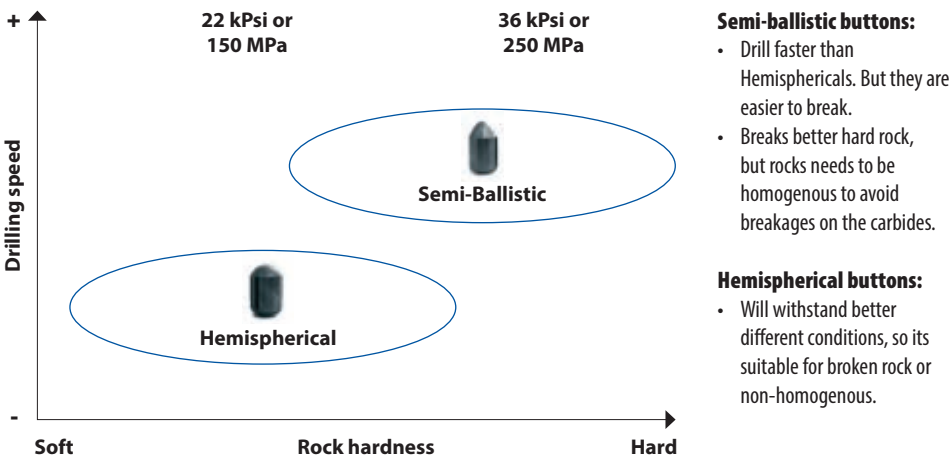



ROBIT® ROD & SHANK MANUFACTURING

Automated Rod Production Line

Fully automated rod production lines with latest technology guarantee consistent top quality.



1

Automated Friction Welding Line

The latest friction welding machine with robot handling systems installed for rod production



2

Rod Straightening

Automatic straightening machine guarantees the best quality product supply to the customers.



3

4



Automated Shank Production Line

Fully automated and robotized shank production lines with 5 axis CNC machines providing top quality products.

5



Quality Inspection & Measurements

State of the art consistent quality inspection and measurement technology in use

6



Scheduled Delivery

All of the Robit products will be delivered for the customers precisely.



Robit® rod descriptions

Example: TH ROD M/F-R32-32R-R32-0915-FC

TH ROD	M/F	R	32	32	R	R	32	0915	FC
Product Group	Thread Design	Thread Type A	Thread Ø Size [mm]	Steel Ø Size [mm]	Rod Design	Thread Type B	Thread Ø Size [mm]	Rod Length [mm]	Treatment
TH DRIFTER ROD	M/M	R	32-60	25-60	R = Round	R	25-60	0915-6440	FC = Fully carburized
TH ROD	M/F	C			H = Hexagonal	C			
		RG				RG			

Thread type

R



C



Material profile

Round



Hexagonal



Robit® Drill Rods

- *Produced from the carefully selected hollow drill steels, Robit® drill rods provide the advantages of the maximum strength with long thread life.*
- *Stiff drill steel will provide improved hole straightness.*
- *Automated drill rod production will ensure consistent top quality of Robit® drill rods*
- *Competitive offering of Drifter rods, Extension rods, Drill tubes and Guide tubes to suit all your drilling needs.*
- *Available with most types of threads and standard lengths*



Robit® Shank Adapters

- *With specially developed alloys, Robit® shank adapters are heat treated to achieve the optimum balance of core strength and case hardness properties to offer extended wear and fatigue life for increased productivity.*
- *Compatible with most brands of drifters in the market.*



DRIFTING AND TUNNELING



DRIFTING AND TUNNELING

Bolting - Drifting - Reaming



MEDIUM AND
HARD ROCK MODEL

A

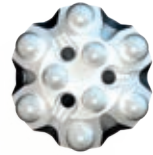

ALL-ROUND MODEL

S

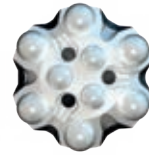

HEAVY DUTY
ALL-ROUND MODEL

S HD



SOFT AND MEDIUM
HARD ROCK MODEL

















M

Please note: Face designs might vary depending on bit diameter.



R25
1" thread

R25 (1") . threads

Order code	Diameter		Body	Gauge	Max OD**	Buttons				Flushing		Product number		Weight	Pcs/box
	[mm]	[in]										[kg]			
					[mm]	[No.]	[mm]	[No.]	[mm]	[No.]	[No.]	[Hemispherical]	[Semi-Ballistic]		
TH RBIT 25R032A	32	1 ¼"		30°	32,9	2 x 7	5 x 7	1	2	2003000*	2003001	0,3	20		
TH RBIT 25R033A	33	1 ⅝"		30°	33,2	2 x 7	5 x 7	1	2	2003002	2003003	0,3	20		
TH RBIT 25R035M	35	1 ⅜"		30°	37,2	2 x 8	6 x 8	2	2	2003043*	2003042*	0,4	20		
TH RBIT 25R038M	38	1 ½"		30°	39,9	2 x 8	6 x 8	2	2	2002666	2002667*	0,5	18		
TH RBIT 25R041M	41	1 ⅝"		35°	43,2	2 x 8	6 x 9	2	2	2003044	2003111*	0,5	18		
TH RBIT 25R043S	43	1 11/16"		30°	45	3 x 8	6 x 9	3	3	2003011	2003067	0,6	10		
TH RBIT 25R045S HD	45	1 ¾"		35°	48,3	3 x 8	6 x 10	3	3	2003018	2003114*	0,8	10		

***Best seller**

**Drill hole maximum OD with Semi-Ballistic buttons



25R032A
25R033A



25R035M
25R038M



25R041M



25R043S



25R045S HD

Drifter Rod - R25 (1") bit thread







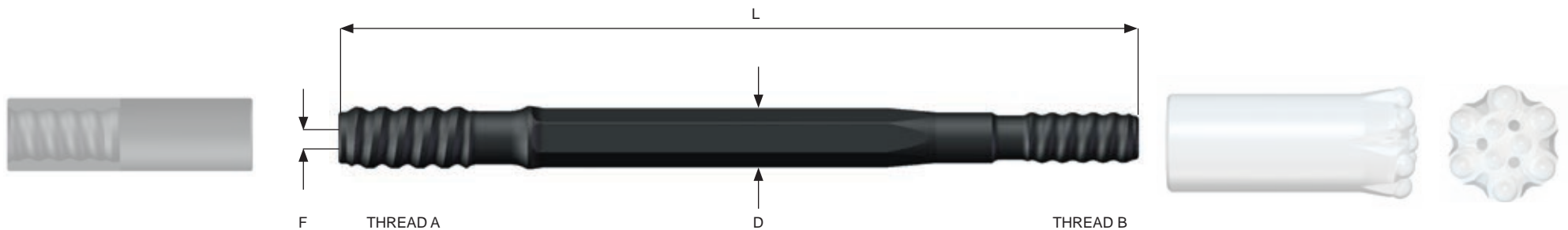

Order code	Length		Diameter D	Thread		Flushing F	Product number	Weight [kg]	Pcs/box 
	[mm]	[ft - in]		[A]	[B]				

Drifter Rod R32 - Hex25 - R25

TH Drifter Rod M/M R32-25H-R25 2175	2175	7' 1 10/16"	HEX25	R32	R25	8,6	06D-07-6029	8,5	60
TH Drifter Rod M/M R32-25H-R25 2400	2400	7' 10 1/2"	HEX25	R32	R25	8,6	06D-07-6433	9,5	60
TH Drifter Rod M/M R32-25H-R25 2475	2475	8' 1 7/16"	HEX25	R32	R25	8,6	06D-07-5680	9,6	60
TH Drifter Rod M/M R32-25H-R25 2630	2630	8' 7 3/8"	HEX25	R32	R25	8,6	06D-07-6030	10,2	60
TH Drifter Rod M/M R32-25H-R25 2750	2750	9' 1/4"	HEX25	R32	R25	8,6	06D-07-4347	10,6	60
TH Drifter Rod M/M R32-25H-R25 2795	2795	9' 2 1/32"	HEX25	R32	R25	8,6	06D-07-5122	10,8	60
TH Drifter Rod M/M R32-25H-R25 3090	3090	10' 1 5/8"	HEX25	R32	R25	8,6	06D-07-5841	12,0	60
TH Drifter Rod M/M R32-25H-R25 3340	3340	10' 11 1/2"	HEX25	R32	R25	8,6	3000039	13,0	60
TH Drifter Rod M/M R32-25H-R25 4000	4000	13' 1 1/2"	HEX25	R32	R25	8,6	06D-07-6801	15,5	60



R28 (1 1/8") - threads

Order code	Diameter		Body	Gauge	Max OD**	Buttons				Flushing		Product number		Weight	Pcs/box	
	[mm]	[in]					[mm]	[No.]	[mm]	[No.]	[mm]	[No.]	[No.]			[Hemispherical]
TH RBIT 28R038M	38	1 1/2"		30°	39,9	2 x 8	6 x 8	2	2				2002663*	2002664	0,5	18
TH RBIT 28R045S	45	1 3/4"		35°	47,9	3 x 8	6 x 9	3	3				2003016	2003017	0,8	10

*Best seller

**Drill hole maximum OD with Semi-Ballistic buttons



28R038M



28R045S

Drifter Rod - R28 (1 1/8") bit thread



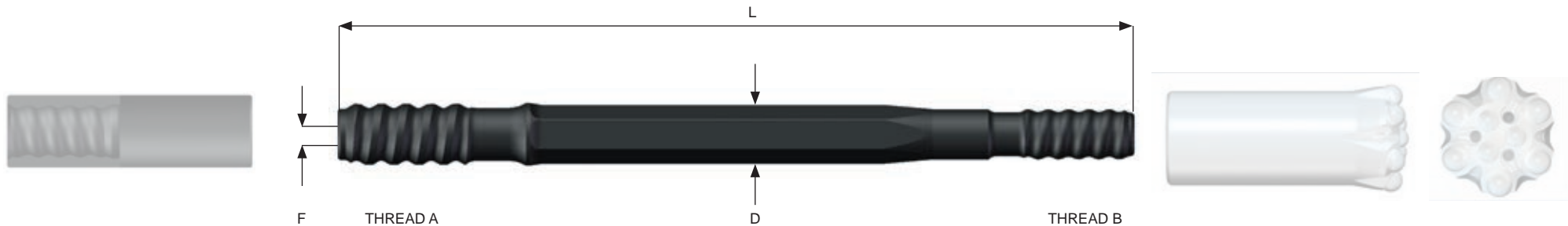



Order code	Length		Diameter D	Thread		Flushing F	Product number	Weight [kg]	Pcs/box 
	[mm]	[ft - in]		[A]	[B]				
Drifter Rod R32 - Hex28 - R28									
TH Drifter Rod M/M R32-28H-R28 1870	1870	6' 1 5/8"	HEX28	R32	R28	8,8	3000020	9,5	60
TH Drifter Rod M/M R32-28H-R28 2175	2175	7' 1 10/16"	HEX28	R32	R28	8,8	06D-07-6032	11,0	60
TH Drifter Rod M/M R32-28H-R28 2475	2475	8' 1 7/16"	HEX28	R32	R28	8,8	06D-07-6033	12,5	60
TH Drifter Rod M/M R32-28H-R28 2795	2795	9' 2"	HEX28	R32	R28	8,8	06D-07-6035	14,1	60
TH Drifter Rod M/M R32-28H-R28 3090	3090	10' 1 5/8"	HEX28	R32	R28	8,8	06D-07-6037	15,6	60
TH Drifter Rod M/M R32-28H-R28 3340	3340	10' 11 1/2"	HEX28	R32	R28	8,8	06D-07-0115	16,9	60
TH Drifter Rod M/M R32-28H-R28 3700	3700	12' 1 5/8"	HEX28	R32	R28	8,8	06D-07-6570	18,7	60



R32 **Rbit™** CONSISTENT HIGH QUALITY

1 1/4" thread

R32 (1 1/4") - threads

Order code	Diameter		Body	Gauge	Buttons				Flushing		Product number		Weight [kg]	Pcs/box
	[mm]	[in]			[No.]	[mm]	[No.]	[mm]	[No.]	[No.]	[Hemispherical]	[Semi-Ballistic]		
TH RBIT 32R041M	41	1 5/8"		35°	2 x 8	6 x 9	2	2	2003008	2003110	0,6	18		
TH RBIT 32R043S	43	1 11/16"		30°	3 x 8	6 x 9	3	3	2003060	2002462	0,7	10		
TH RBIT 32R043S HD	43	1 11/16"		30°	3 x 8	6 x 10	3	3	2002463	2002464*	0,8	10		
TH RBIT 32R045S	45	1 3/4"		35°	3 x 8	6 x 9	3	3	2002611*	2002612*	0,8	10		
TH RBIT 32R045S HD	45	1 3/4"		35°	3 x 8	6 x 10	3	3	2002613	2002614*	0,8	10		
TH RBIT 32R045A	45	1 3/4"		30°	2 x 9	5 x 11	1	2	2003112*	2003113	0,8	10		

*Best seller



32R041M



32R043S



32R043S HD



32R045S



32R045S HD















32R045A

TOP PERFORMANCE WITH **Rbit™** R32

1 ¼" thread

R32 (1 ¼") - threads

Order code	Diameter		Body	Gauge	Buttons				Flushing		Product number		Weight [kg]	Pcs/box
	[mm]	[in]			↘	[No.] [mm]	[No.] [mm]	[No.] [No.]	[No.] [No.]	[Hemispherical]	[Semi-Ballistic]			
TH RBIT 32R048S	45	1 ¾"		35°	3 x 9	6 x 10	3	3			2002579*	2002580*	1,0	10
TH RBIT 32R051S	51	2"		35°	3 x 9	6 x 10	3	3			2003116*	2002607*	1,0	10
TH RBIT 32R054S	54	2 ⅛"		35°	3 x 9	6 x 10	3	3			2003032	2003033	1,0	4
TH RBIT 32R057S	57	2 ¼"		35°	3 x 10	6 x 10	3	3			2003056	2003036	1,1	4

*Best seller



32R048S
32R051S



32R054S
32R057S

R32 RODS - CONSISTENT HIGH QUALITY

1 ¼" thread

Drifter Rod - R32 (1 ¼") bit thread

Order code	Length		Diameter	Thread		Flushing	Product number	Weight	Pcs/box
	L			D					
	[mm]	[ft - in]	[mm]	[A]	[B]	[mm]		[kg]	

Drifter Rod R38 - Hex32 - R32

TH Drifter Rod M/M R38-32H-R32 3090	3090	10' 1 5/8"	HEX32	R38	R32	9,6	06D-07-2886	19,7	50
TH Drifter Rod M/M R38-32H-R32 3700	3700	12' 1 5/8"	HEX32	R38	R32	9,6	06D-07-2887	23,6	40
TH Drifter Rod M/M R38-32H-R32 4305	4305	14' 1 1/2"	HEX32	R38	R32	9,6	06D-07-2143	27,4	30
TH Drifter Rod M/M R38-32H-R32 4915	4915	16' 1 1/2"	HEX32	R38	R32	9,6	06D-07-6438	31,3	30

Drifter Rod R38 - Hex35 - R32

TH Drifter Rod M/M R38-35H-R32 3090	3090	10' 1 5/8"	HEX35	R38	R32	9,5	06D-07-2892	23,9	50
TH Drifter Rod M/M R38-35H-R32 3700	3700	12' 1 5/8"	HEX35	R38	R32	9,5	06D-07-2894	28,7	40
TH Drifter Rod M/M R38-35H-R32 4305	4305	14' 1 1/2"	HEX35	R38	R32	9,5	06D-07-2709	33,5	30

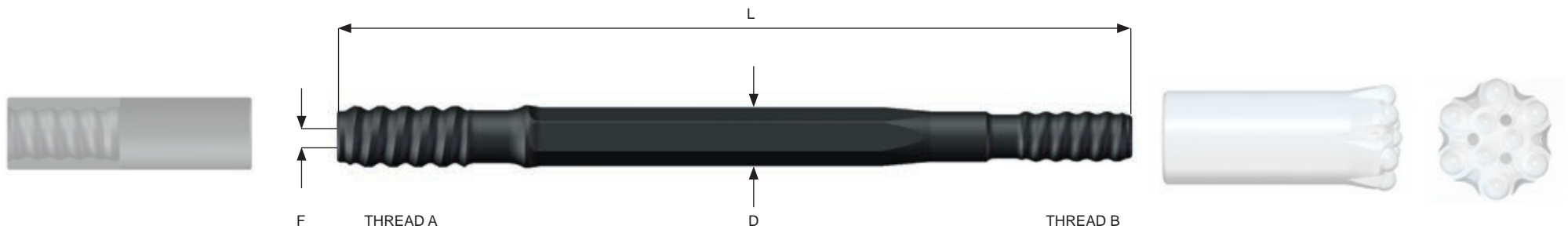

Drifter Rod - R32 (1 ¼") bit thread

Order code	Length		Diameter	Thread		Flushing	Product number	Weight	Pcs/box
	L			D	[A]				
	[mm]	[ft - in]	[mm]			[mm]		[kg]	

Drifter Rod C38 - Hex32 - R32

TH Drifter Rod M/M C38-32H-R32 2400	2400	7' 10 ½"	HEX32	C38	R32	9,6	06D-07-3686	15,3	50
TH Drifter Rod M/M C38-32H-R32 3090	3090	10' 1 ⅝"	HEX32	C38	R32	9,6	06D-07-2889	19,7	50
TH Drifter Rod M/M C38-32H-R32 3700	3700	12' 1 ⅜"	HEX32	C38	R32	9,6	06D-07-2890	23,6	50
TH Drifter Rod M/M C38-32H-R32 4305	4305	14' 1 ½"	HEX32	C38	R32	9,6	06D-07-2750	27,4	30

Drifter Rod C38 - Hex35 - R32

TH Drifter Rod M/M C38-35H-R32 3090	3090	10' 1 ⅝"	HEX35	C38	R32	9,5	06D-07-2895	23,9	50
TH Drifter Rod M/M C38-35H-R32 3700	3700	12' 1 ⅝"	HEX35	C38	R32	9,5	06D-07-2897	28,7	40
TH Drifter Rod M/M C38-35H-R32 4305	4305	14' 1 ½"	HEX35	C38	R32	9,5	06D-07-0891	33,5	30
TH Drifter Rod M/M C38-35H-R32 4915	4915	16' 1 ½"	HEX35	C38	R32	9,5	06D-07-3965	38,3	30
TH Drifter Rod M/M C38-35H-R32 5525	5525	18' 1 ½"	HEX35	C38	R32	9,5	06D-07-3966	43,1	30

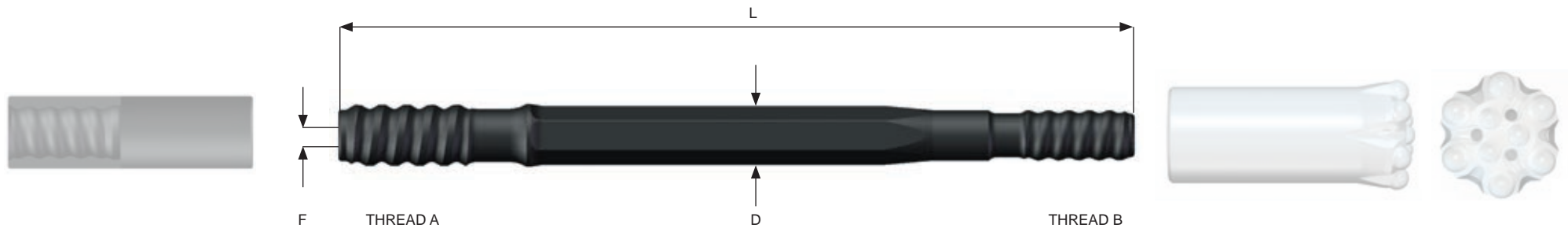

R32 RODS - CONSISTENT HIGH QUALITY

1 1/4" thread

Extension Rod (Male/Male) - R32 (1 1/4") bit thread

Order code	Length		Diameter	Thread		Flushing	Product number	Weight	Pcs/box
	L			D	[A]				
	[mm]	[ft - in]	[mm]			[mm]		[kg]	

Extension M/M Rod R32 - round 32 - R32 - FC (Fully Carburized also suitable for underground)

TH Rod M/M R32 32R 0915 FC	915	3'	RND32	R32	R32	11,7	06A-07-3247	4,6	50
TH Rod M/M R32 32R 1220 FC	1220	4'	RND32	R32	R32	11,7	06A-07-2899	6,3	50
TH Rod M/M R32 32R 1525 FC	1525	5'	RND32	R32	R32	11,7	06A-07-2900	8,0	50
TH Rod M/M R32 32R 1830 FC	1830	6'	RND32	R32	R32	11,7	06A-07-2901	9,7	50

Extension M/M Rod R32 - round 32 - R32

TH Rod M/M R32 32R 3050	3050	10'	RND32	R32	R32	11,7	06A-07-3241	16,5	50
TH Rod M/M R32 32R 3660	3660	12'	RND32	R32	R32	11,7	06A-07-3242	19,8	50

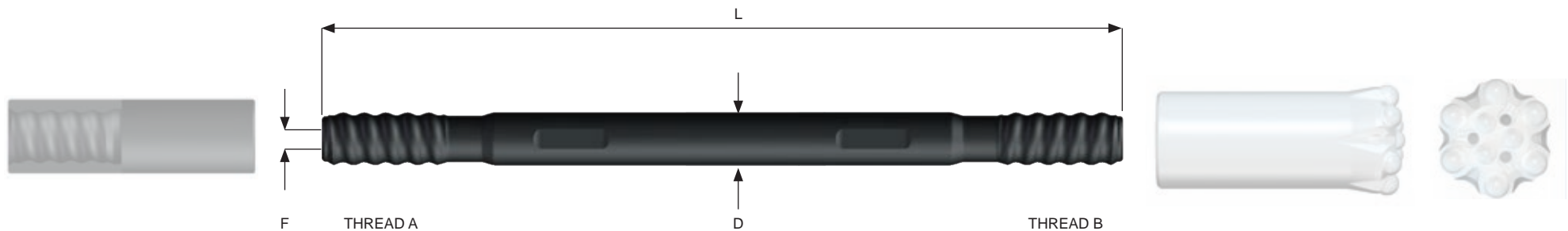

RR34
1 5/16" thread

Robit™ CONSISTENT HIGH QUALITY





-
- Maximum bending stiffness
 - Excellent precision in collaring
 - High durability, longer lifetime
 - Maximized wall thickness
 - Longer bit life
 - Straighter holes
 - Optimized flushing properties
 - Better drilling accuracy
 - Easy coupling/uncoupling

Robit

TOP PERFORMANCE WITH **Rbit™** RR34

1 5/16" thread

RR34 (1 5/16") . threads

Order code	Diameter		Body	Gauge	Buttons		Flushing		Product number		Weight [kg]	Pcs/box
	[mm]	[in]			[No.]	[mm]	[No.]	[No.]	[Hemispherical]	[Semi-Ballistic]		
TH RBIT 34RR043S	43	1 1/16"		30°	3 x 8	6 x 9	3	3	2003009	2003010	0,7	10
TH RBIT 34RR045S HD	45	1 3/4"		35°	3 x 8	6 x 10	3	3	2003054	2002460*	0,8	10
TH RBIT 34RR048S	48	1 7/8"		35°	3 x 9	6 x 10	3	3	2003021	2002454	1,0	10
TH RBIT 34RR051S	51	2"		35°	3 x 9	6 x 10	3	3	2003053	2003026*	1,0	10

*Best seller



34RR043S
34RR048S



34RR045S HD
34RR051S HD

RR34 RODS - CONSISTENT HIGH QUALITY

1 5/16" thread

Drifter Rod - RR34 (1 5/16") bit thread

Order code	Length		Diameter D [mm]	Thread		Flushing F [mm]	Product number	Weight [kg]	Pcs/box 
	L [mm]	[ft - in]		[A]	[B]				
Drifter Rod C38 - RND39 - RR34									
TH Drifter Rod M/M C38-39R-RR34 3700	3700	12' 1 5/8"	RND39	C38	RR34	10,3	06D-07-6635	30,0	30
TH Drifter Rod M/M C38-39R-RR34 5525	5525	18' 1 1/2"	RND39	C38	RR34	10,3	06D-07-3971	47,9	20
TH Drifter Rod M/M C38-39R-RR34 6135	6135	20' 1 1/2"	RND39	C38	RR34	10,3	06D-07-3972	51,2	20
TH Drifter Rod M/M C38-39R-RR34 6440	6440	21'	RND39	C38	RR34	10,3	06D-07-3973	55,4	20

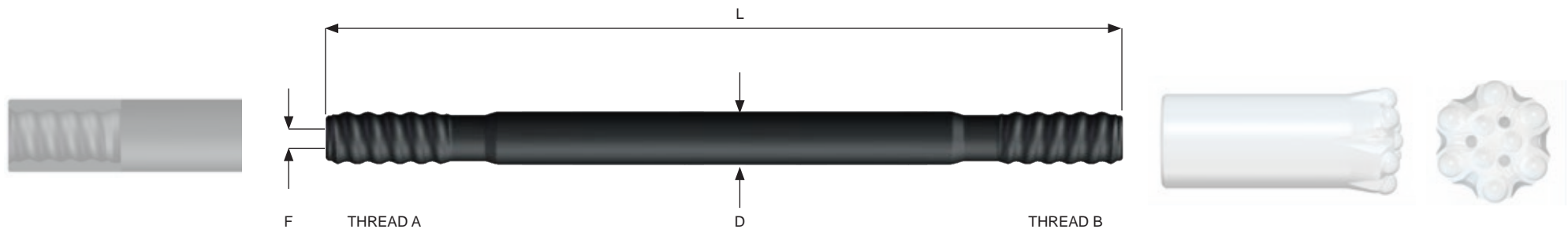

TOP PERFORMANCE - RODS RR34

1 5/16" thread

Drifter Rod - RR34 (1 5/16") bit thread

Order code	Length		Diameter	Thread		Flushing	Product number	Weight	Pcs/box
	L			D	[A]				
	[mm]	[ft - in]	[mm]			[mm]		[kg]	
Drifter Rod C38 - Hex35 - RR34									
TH Drifter Rod M/M C38-35H-RR34 3700	3700	12' 1 5/8"	HEX35	C38	RR34	9,5	06D-07-5324	28,7	40
TH Drifter Rod M/M C38-35H-RR34 4305	4305	14' 1 1/2"	HEX35	C38	RR34	9,5	06D-07-3967	33,5	30
TH Drifter Rod M/M C38-35H-RR34 4915	4915	16' 1 1/2"	HEX35	C38	RR34	9,5	06D-07-3968	38,2	30
TH Drifter Rod M/M C38-35H-RR34 5525	5525	18' 1 1/2"	HEX35	C38	RR34	9,5	06D-07-3969	43,0	30

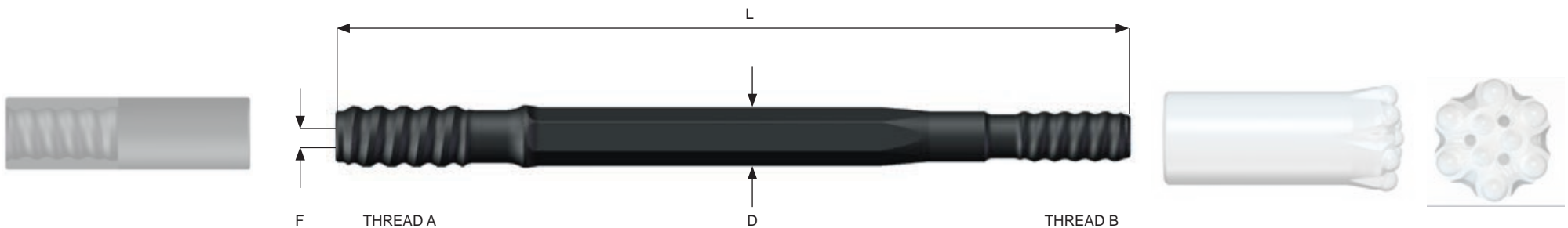

LONG HOLE DRILLING



LONG HOLE DRILLING

Production drilling



All-Round Model

S, S HD



Flat Face for medium and hard rock conditions

FF, FFR

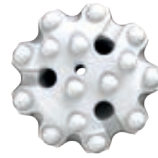

Flat Face Heavy Duty model for more abrasive conditions

FF HD, FFR HD



Drop Center model for straighter holes with maximum flushing properties. (For soft and medium hard rock)

DC, DCR



Drop Center Heavy Duty model for more abrasive conditions

DC HD, DCR HD

Please note: Face designs might vary depending on bit diameter.

“Robit offers the best customer experience.”









Robit

Long Hole Drilling

R32 **Rbit™** CONSISTENT HIGH QUALITY

1 ¼" thread

R32 (1 ¼") . threads

Order code	Diameter		Body	Gauge	Buttons				Flushing		Product number		Weight [kg]	Pcs/box
	[mm]	[in]			↘	[No.] [mm]	[No.] [mm]	[No.] [mm]	[No.] [mm]	[Hemispherical]	[Semi-Ballistic]			
TH RBIT 32R051S	51	2"		35°	3 x 9	6 x 10	3	3	2003116*	2002607*	1,0	10		
TH RBIT 32R054S	54	2 ⅛"		35°	3 x 9	6 x 10	3	3	2003032	2003033	1,0	4		
TH RBIT 32R057S	57	2 ¼"		35°	3 x 10	6 x 10	3	3	2003056	2003036	1,1	4		
TH RBIT 32R064FFR	64	2 ½"		35°	4 x 9	8 x 10	3	-	04-132-064-0385*	04-132-064-0387	2,0	4		
TH RBIT 32R064DC HD	64	2 ½"		35°	5 x 9	8 x 10	5	-	2001186	2001187	1,5	4		
TH RBIT 32R064DCR HD	64	2 ½"		35°	5 x 9	8 x 10	5	-	2000685	2000686	2,0	4		

*Best seller



32R051S
32R054S
32R057S



32R064FFR



32R064DC HD



32R064DCR HD

Extension Rod (Male/Female) - R32 (1 1/4") bit thread

Order code	Length		Diameter	Thread		Flushing	Product number	Weight	Pcs/box
	L			D	[A]				
	[mm]	[ft - in]	[mm]			[mm]		[kg]	

Extension M/F Rod R32 - round 32 - R32 - FC (Fully Carburized also suitable for underground)



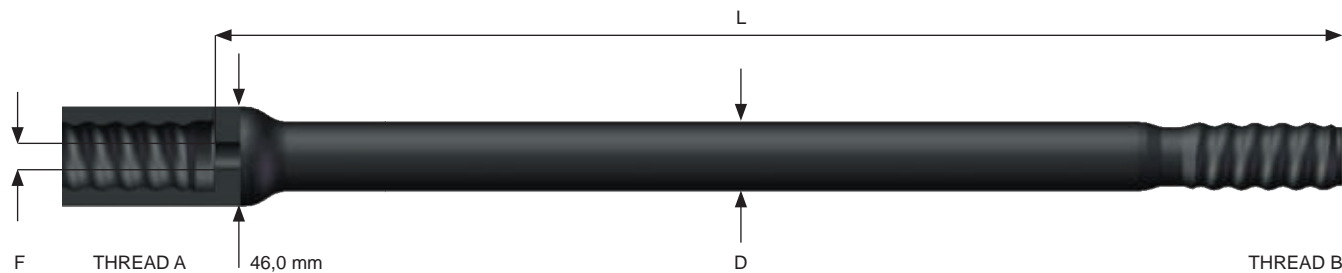





TH Rod M/F R32 32R 0915 FC	915	3'	RND32	R32	R32	11,7	06B-07-2910	5,3	40
TH Rod M/F R32 32R 1220 FC	1220	4'	RND32	R32	R32	11,7	06B-07-2876	7,3	40
TH Rod M/F R32 32R 1525 FC	1525	5'	RND32	R32	R32	11,7	06B-07-2419	8,9	40
TH Rod M/F R32 32R 1830 FC	1830	6'	RND32	R32	R32	11,7	06B-07-3020	10,5	40



C38 **Rbit™** CONSISTENT HIGH QUALITY

1 ½" thread

C38 (1 ½") . threads

Order code	Diameter		Body	Gauge	Buttons				Flushing		Product number		Weight [kg]	Pcs/box
	[mm]	[in]			[No.]	[mm]	[No.]	[mm]	[No.]	[No.]	[Hemispherical]	[Semi-Ballistic]		
TH RBIT 38C064FF	64	2 ½"		35°	4 x 9	8 x 10	3	-	01-238-064-2244	01-238-064-2245	1,7	4		
TH RBIT 38C064FFR HD	64	2 ½"		35°	4 x 10	8 x 11	3	-	01-238-064-2271	01-238-064-2272	1,9	4		
TH RBIT 38C064DC HD	64	2 ½"		35°	5 x 9	8 x 10	5	-	2000452*	2000453	1,6	4		
TH RBIT 38C064DCR HD	64	2 ½"		35°	5 x 9	8 x 10	5	-	01-238-064-0864*	01-238-064-0865*	1,9	4		
TH RBIT 38C070DCR	70	2 ¾"		35°	5 x 10	8 x 10	5	-	2000689	2000690	2,6	4		
TH RBIT 38C076FF	76	3"		35°	5 x 10	9 x 10	4	-	01-238-076-2048	01-238-076-2049	2,3	4		
TH RBIT 38C076FFR	76	3"		35°	5 x 10	9 x 10	4	-	01-238-076-2157	01-238-076-2158	3,2	4		
TH RBIT 38C076DC	76	3"		35°	5 x 11	8 x 11	5	-	2000449	2000450	2,2	4		
TH RBIT 38C076DCR	76	3"		35°	5 x 11	8 x 11	5	-	2000446	2000447*	3,2	4		

*Best seller



38C064FF



38C064FFR HD



38C064DC HD



38C064DCR HD
38C070DCR
38C076DCR



38C076FF



38C076FFR



38C076DC

Extension Rod (Male/Female) - C38 (1 1/2") bit thread

Order code	Length		Diameter D [mm]	Thread		Flushing F [mm]	Product number	Weight [kg]	Pcs/box 
	L [mm]	[ft - in]		[A]	[B]				

Extension M/F Rod C38 - round 39 - C38 - FC (Fully Carburized also suitable for underground)



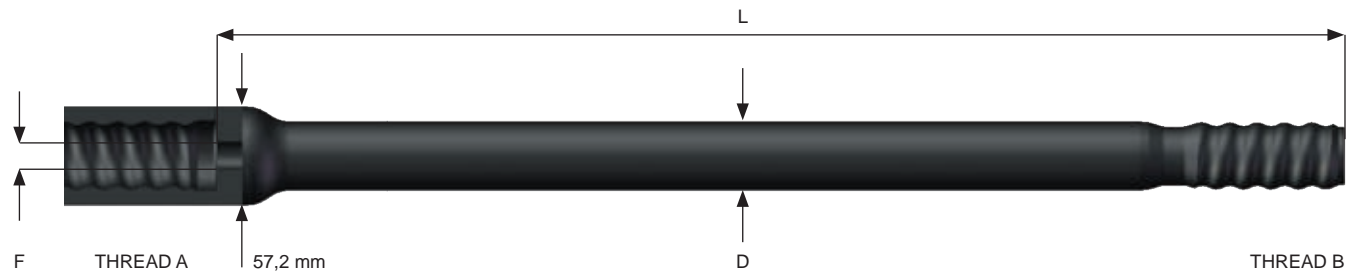





TH Rod M/F C38 39R 1220 FC	1220	4'	RND39	C38	C38	14,5	06B-07-2911	10,9	32
TH Rod M/F C38 39R 1525 FC	1525	5'	RND39	C38	C38	14,5	06B-07-2420	13,5	24
TH Rod M/F C38 39R 1830 FC	1830	6'	RND39	C38	C38	14,5	06B-07-2879	16,0	24



C45 **Rbit™** CONSISTENT HIGH QUALITY

1 3/4" thread

C45 (1 3/4") - threads

Order code	Diameter		Body	Gauge	Buttons				Flushing		Product number		Weight [kg]	Pcs/box
	[mm]	[in]			[No.]	[mm]	[No.]	[mm]	[No.]	[No.]	[Hemispherical]	[Semi-Ballistic]		
TH RBIT 45C070DCR	70	2 3/4"		35°	5 x 10	8 x 10	5	-	2000695	2000696*	2,5	4		
TH RBIT 45C076FF	76	3"		35°	5 x 10	9 x 10	4	-	01-245-076-2350*	01-245-076-2351	2,7	4		
TH RBIT 45C076FFR HD	76	3"		35°	5 x 10	9 x 11	4	-	01-245-076-2283	01-245-076-2284	2,9	4		
TH RBIT 45C076DC	76	3"		35°	5 x 11	8 x 11	5	-	2000443*	2000444*	2,7	4		
TH RBIT 45C076DCR	76	3"		35°	5 x 11	8 x 11	5	-	01-245-076-0398*	01-245-076-0866*	2,9	4		
TH RBIT 45C089DC	89	3 1/2"		35°	5 x 12	8 x 12	5	-	2000363*	2000364*	3,4	2		
TH RBIT 45C089DCR	89	3 1/2"		35°	5 x 12	8 x 12	5	-	2000113*	2000114*	4,7	2		
TH RBIT 45C089FF	89	3 1/2"		35°	6 x 11	9 x 12	4	-	01-245-089-1169	01-245-089-1172	3,4	2		
TH RBIT 45C089FFR	89	3 1/2"		35°	6 x 11	9 x 12	4	-	01-245-089-1176	01-245-089-1180	4,7	2		

*Best seller



45C070DCR
45C076DCR
45C089DC



45C076FF
45C089FF



45C076FFR HD
45C089FFR



45C076DC



45C089DC

Extension Rod (Male/Female) - C45 (1 3/4") bit thread

Order code	Length		Diameter D [mm]	Thread		Flushing F [mm]	Product number	Weight [kg]	Pcs/box 
	L [mm]	[ft - in]		[A]	[B]				
Extension M/F Rod C45 - round 46 - C45 - FC (Fully Carburized also suitable for underground)									
TH Rod M/F C45 46R 1525 FC	1525	5'	RND46	C45	C45	17,0	06B-07-2421	18,3	24
TH Rod M/F C45 46R 1830 FC	1830	6'	RND46	C45	C45	17,0	06B-07-3019	22,0	24











C51

2" thread

Robit™ CONSISTENT HIGH QUALITY

C51 (2") - threads

Order code	Diameter		Body	Gauge	Buttons				Flushing		Product number		Weight [kg]	Pcs/box
	[mm]	[in]			[No.]	[mm]	[No.]	[mm]	[No.]	[No.]	[No.]	[Hemispherical]		
TH RBIT 51C083FFR HD	83	3 ¼"		35°	6 x 11	9 x 13	4	-	2001699	2001700	3,4	2		
TH RBIT 51C083DCR	83	3 ¼"		35°	5 x 12	8 x 12	5	-	2000158*	2000159*	3,4	2		
TH RBIT 51C089FF HD	89	3 ½"		35°	6 x 12	9 x 13	4	-	01-251-089-1247*	01-251-089-1249	4,1	2		
TH RBIT 51C089FFR	89	3 ½"		35°	6 x 11	9 x 12	4	-	01-251-089-1240*	01-251-089-1243	4,3	2		
TH RBIT 51C089DC	89	3 ½"		35°	5 x 12	8 x 12	5	-	2000037*	2000038	3,7	2		
TH RBIT 51C089DCR	89	3 ½"		35°	5 x 12	8 x 12	5	-	01-251-089-0877*	01-251-089-0878*	4,3	2		
TH RBIT 51C102DC HD	102	4"		35°	5 x 14	8 x 14	5	-	01-251-102-0868*	01-251-102-0869	4,6	1		
TH RBIT 51C102FFR	102	4"		35°	6 x 13	9 x 13	4	-	01-251-102-2559	01-251-102-2732	6,2	1		
TH RBIT 51C102DCR HD	102	4"		35°	5 x 14	8 x 14	5	-	2000103*	2000104*	6,3	1		

*Best seller



51C083FFR HD
51C089FFR
51C102FFR



51C083DCR
51C089DCR
51C102DCR HD



51C089FF HD



51C089DC
51C102DC HD

RODS - CONSISTENT HIGH QUALITY

C51
2" thread

Long Hole Drilling

Extension Rod (Male/Female) - C51 (2") bit thread

Order code	Length		Diameter	Thread		Flushing	Product number	Weight	Pcs/box
	L			D	[A]				
	[mm]	[ft - in]	[mm]			[mm]		[kg]	
Extension M/F Rod C51 - round 52 - C51 - FC (Fully Carburized also suitable for underground)									
TH Rod M/F C51 52R 1525 FC	1525	5'	RND52	C51	C51	21,5	06B-07-3248	22,3	18
TH Rod M/F C51 52R 1830 FC	1830	6'	RND52	C51	C51	21,5	06B-07-2883	26,8	18

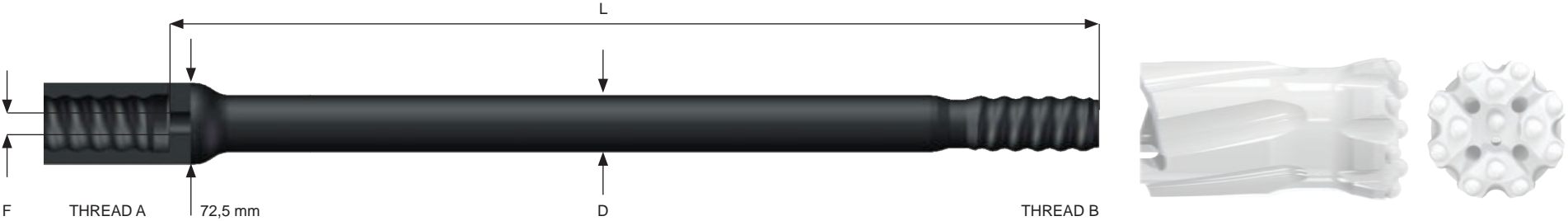

C38, C45 & C51 TOP PERFORMANCE - GUIDE TUBES

1 1/2", 1 3/4", 2" thread

C38, C45 & C51 (1 1/2", 1 3/4", 2") . threads



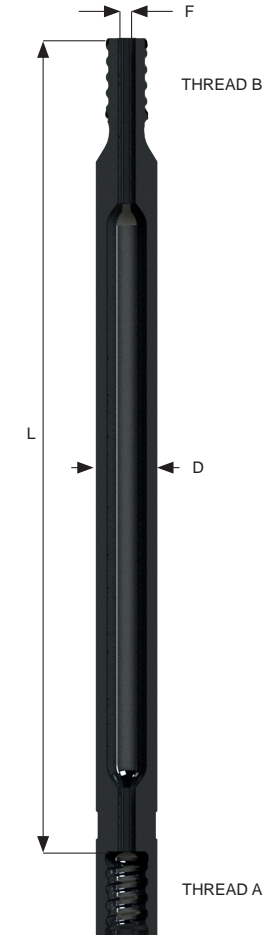



Order code	Length		Diameter	Thread		Flushing	Product number	Weight	Pcs/box 
	L			D					
	[mm]	[ft - in]	[mm]	[A]	[B]	[mm]	[kg]		
TH Guide Tube M/F C38 56T 1220	1220	4'	56	C38	C38	14,5	3000154	15,6	24
TH Guide Tube M/F C38 56T 1525	1525	5'	56	C38	C38	14,5	3000158	19,3	24
TH Guide Tube M/F C38 56T 1830	1830	6'	56	C38	C38	14,5	3000115	23,0	24
TH Guide Tube M/F C45 65T 1220	1220	4'	65	C45	C45	18	3000156	21,8	24
TH Guide Tube M/F C45 65T 1525	1525	5'	65	C45	C45	18	3000157	26,9	24
TH Guide Tube M/F C45 65T 1830	1830	6'	65	C45	C45	18	3000117	32,0	24
TH Guide Tube M/F C51 76T 1220	1220	4'	76	C51	C51	22	3000159	28,2	18
TH Guide Tube M/F C51 76T 1525	1525	5'	76	C51	C51	22	3000160	34,5	18
TH Guide Tube M/F C51 76T 1830	1830	6'	76	C51	C51	22	3000119	40,8	18



Rbit™ CONSISTENT HIGH QUALITY CT38, CT45, CT58 & CT68

1 1/2", 1 3/4", 2 1/4" & 2 11/16" thread

CT38, CT45, CT58 & CT68 (1 1/2", 1 3/4", 2 1/4" & 2 11/16") - threads (shoulder drive)

Order code	Diameter		Body	Gauge	Buttons			Flushing		Product number		Weight [kg]	Pcs/box
	[mm]	[in]			↘	[No.] [mm]	[No.] [mm]	[No.] [No.]	[No.] [No.]	[Hemispherical]	[Semi-Ballistic]		
TH RBIT 38CT064DCR HD	64	2 1/2"		35°	5 x 9	8 x 10	5	-	2000713	2000714	2,1	4	
TH RBIT 45CT076DCR	76	3"		35°	5 x 11	8 x 11	5	-	2000715	2000716	3,0	4	
TH RBIT 45CT089DCR	89	3 1/2"		35°	5 x 12	8 x 12	5	-	2000717	2000718	4,6	2	
TH RBIT 58CT089DCR	89	3 1/2"		35°	5 x 12	8 x 12	5	-	2000582	2000583*	4,5	2	
TH RBIT 68CT102FF	102	4"		35°	6 x 13	9 x 13	4	-	01-368-102-2133	01-368-102-2134	5,4	1	
TH RBIT 68CT102DC HD	102	4"		35°	5 x 14	8 x 14	5	-	2000719	2000720	5,4	1	
TH RBIT 68CT102DCR HD	102	4"		35°	5 x 14	8 x 14	5	-	2000496	2000497*	5,8	1	

*Best seller

C38 and C45 standard body drill bits are also compatible with CT38 and CT45 shoulder drive drill tubes



38CT064DCR HD
45CT076DCR
45CT089DCR
68CT102DCR HD



68CT102FF



68CT102DC HD
68CT115DC HD

CT38, CT45, CT58 & CT68 TOP PERFORMANCE - DRILL TUBES

1 1/2", 1 3/4", 2 1/4" & 2 11/16" thread

CT38, CT45, CT58 & CT68 (1 1/2", 1 3/4", 2 1/4" & 2 11/16") - threads (shoulder drive)

Order code	Length		Diameter		Thread		Flushing	Product number	Weight	Pcs/box
	L		D				F			
	[mm]	[ft - in]	[mm]		[A]	[B]	[mm]	[kg]		
TH Drill Tube M/F CT38 56T 1220	1220	4'	56		CT38	CT38	14,5	2000218	16,1	24
TH Drill Tube M/F CT38 56T 1525	1525	5'	56		CT38	CT38	14,5	2000217	19,8	24
TH Drill Tube M/F CT38 56T 1830	1830	6'	56		CT38	CT38	14,5	08-238-056-0470	23,5	24
TH Drill Tube M/F CT45 65T 1220	1220	4'	65		CT45	CT45	17	08-245-065-0716	22,0	24
TH Drill Tube M/F CT45 65T 1525	1525	5'	65		CT45	CT45	17	08-245-065-0717	27,2	24
TH Drill Tube M/F CT45 65T 1830	1830	6'	65		CT45	CT45	17	08-245-065-6802	32,3	24
TH Drill Tube M/F CT58 76T 1220	1220	4'	76		CT58	CT58	26	2000216	28,5	18
TH Drill Tube M/F CT58 76T 1525	1525	5'	76		CT58	CT58	26	2000215	34,8	18
TH Drill Tube M/F CT58 76T 1830	1830	6'	76		CT58	CT58	26	2000001	41,1	18
TH Drill Tube M/F CT68 87T 1220	1220	4'	87		CT68	CT68	30	2000214	34,8	18
TH Drill Tube M/F CT68 87T 1525	1525	5'	87		CT68	CT68	30	2000152	42,2	18
TH Drill Tube M/F CT68 87T 1830	1830	6'	87		CT68	CT68	30	2000002	49,6	18

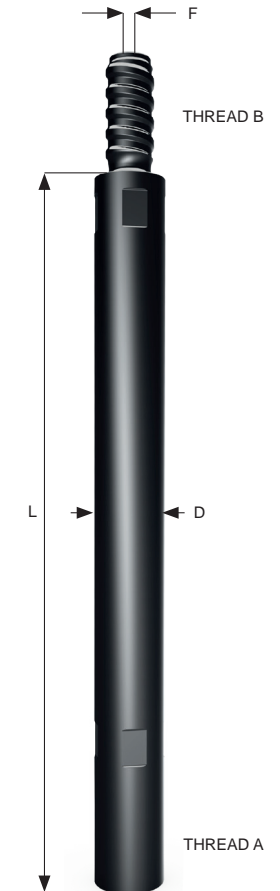

REAMING EQUIPMENT



REAMING EQUIPMENT

Pilot adapters - Chisels - Reamers - Dome reamers

Please note: Face designs might vary depending on bit diameter.



Reaming
Equipment

R28

1 1/8" thread

R32

1 1/4" thread

RR34

1 5/16" thread

C38

1 1/2" thread

CT45

1 3/4" thread

CT58

2 1/4" thread

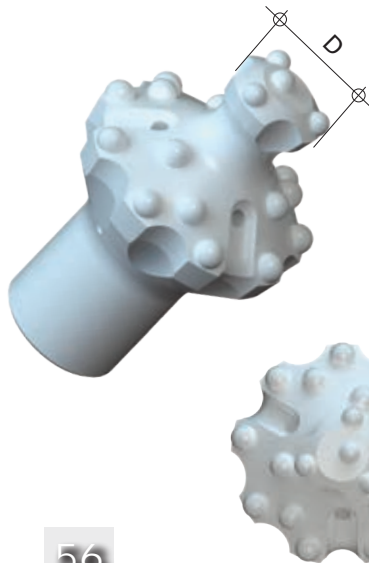

R28 (1 1/8"), R32 (1 1/4"), RR34 (1 5/16"), C38 (1 3/8"), CT45 (1 3/4") & CT58 (2 1/4") - threads

Order code	Diameter		Pilot diameter D		Buttons		Flushing		Product number	Weight
	[mm]	[in]	[mm]	[in]	[No.]	[mm]	[No.]	[mm]		
Dome reamers										
TH RBIT 28R076 DOME	76	3"	35	1 3/8"	4 x 8	12 x 11	4	2	2003061	1,9
TH RBIT 32R076 DOME	76	3"	40	1 5/8"	4 x 8	12 x 11	4	2	2003039*	1,8
TH RBIT 32R089 DOME	89	3 1/2"	40	1 5/8"	4 x 9	12 x 12	4	2	2003040*	2,4
TH RBIT 32R102 DOME	102	4"	44	1 3/4"	4 x 10	15 x 12	3	2	2003119*	3,2
TH RBIT 32R127 DOME	127	5"	44	1 3/4"	4 x 10	15 x 14	3	2	2003055	5,2
TH RBIT 34RR089 DOME	89	3 1/2"	40	1 5/8"	4 x 9	12 x 12	4	2	2003052	2,4
TH RBIT 34RR102 DOME	102	4"	44	1 3/4"	4 x 10	15 x 12	3	2	2002652*	3,1
TH RBIT 38C127 DOME	127	5"	58	2 1/4"	4 x 12	15 x 14	3	2	2003120*	5,7
TH RBIT 38C152 DOME	152	6"	73	2 7/8"	3 x 14	21 x 14	4	2	2003045	9,3
TH RBIT 45CT127 DOME	127	5"	58	2 1/4"	4 x 12	15 x 14	3	2	2003041	6,8
TH RBIT 45CT152 DOME	152	6"	73	2 7/8"	3 x 14	21 x 14	4	2	2003121*	10,0
TH RBIT 45CT180 DOME	180	7"	73	2 7/8"	3 x 14	21 x 16	4	2	2003071	14,2
TH RBIT 58CT152 DOME	152	6"	80	3 1/8"	3 x 14	21 x 14	4	2	2003070	10,5

*Best seller

TOP PERFORMANCE - REAMERS, CHISELS & ADAPTERS

R32

1 1/4" thread

R35

1 3/8" thread

R32 (1 1/4") & R35 (1 3/8") . threads

Order code	Buttons		Flushing		Product number		Weight [kg]
	[No.]	[mm]	[No.]	[mm]	[Hemispherical]	[Semi-Ballistic]	
Adapters							
Pilot adapter R32/R32			1	2	04-132-132-0410	-	2,4
Pilot adapter R35/R35			1	2	04-135-135-0464	-	2,4
Pilot adapter R32 Chisel D40			1	2	06L-24-0609	-	2,5
Pilot adapter R35 Chisel D40			1	2	06L-24-0608	-	2,5
Reamers							
Reamer 89	4 x 10	8 x 12	-	-	04-012-089-0285	-	1,8
Reamer 102	4 x 12	8 x 12	-	-	04-012-102-0286	-	2,5
Reamer 127	4 x 14	8 x 14	-	-	04-012-127-0287	-	3,3



Reaming
Equipment

SURFACE DRILLING



Robit

Robit

SURFACE DRILLING



Flat Face for medium and hard rock conditions

FF, FFR



Flat Face Heavy Duty model for more abrasive conditions

FF HD, FFR HD



Drop Center model for straighter holes with maximum flushing properties. (For soft and medium hard rock)

DC, DCR



Drop Center Heavy Duty model for more abrasive conditions

DC HD, DCR HD

Please note: Face designs might vary depending on bit diameter.





"Robit offers the best customer experience."



Surface Drilling

Robit

R32 (1 ¼") - threads

Order code	Diameter		Body	Gauge	Buttons				Flushing		Product number		Weight [kg]	Pcs/box
	[mm]	[in]			[No.]	[mm]	[No.]	[mm]	[No.]	[No.]	[No.]	[Hemispherical]		
TH RBIT 32R064FF	64	2 ½"		35°	4 x 9	8 x 10	3	-	04-132-064-2037	04-132-064-2038	1,5	4		
TH RBIT 32R064FFR	64	2 ½"		35°	4 x 9	8 x 10	3	-	04-132-064-0385*	04-132-064-0387	2,0	4		
TH RBIT 32R064DC HD	64	2 ½"		35°	5 x 9	8 x 10	5	-	2001186	2001187	1,5	4		
TH RBIT 32R064DCR HD	64	2 ½"		35°	5 x 9	8 x 10	5	-	2000685	2000686	2,0	4		

*Best seller



32R064FF



32R064FFR



32R064DC HD



32R064DCR HD

Extension Rod (Male/Female & Male/Male) - R32 (1 1/4") bit thread

Order code	Length		Diameter	Thread		Flushing	Product number	Weight	Pcs/box
	L			D	[A]				
	[mm]	[ft - in]	[mm]			[mm]		[kg]	

Extension M/F Rod R32 - round 32 - R32

TH Rod M/F R32 32R 3050	3050	10'	RND32	R32	R32	11,7	06B-07-2877	17,1	32
TH Rod M/F R32 32R 3660	3660	12'	RND32	R32	R32	11,7	06B-07-2492	20,9	32

Extension M/M Rod R32 - round 32 - R32

TH Rod M/M R32 32R 3050	3050	10'	RND32	R32	R32	11,7	06A-07-3241	16,5	50
TH Rod M/M R32 32R 3660	3660	12'	RND32	R32	R32	11,7	06A-07-3242	19,8	50

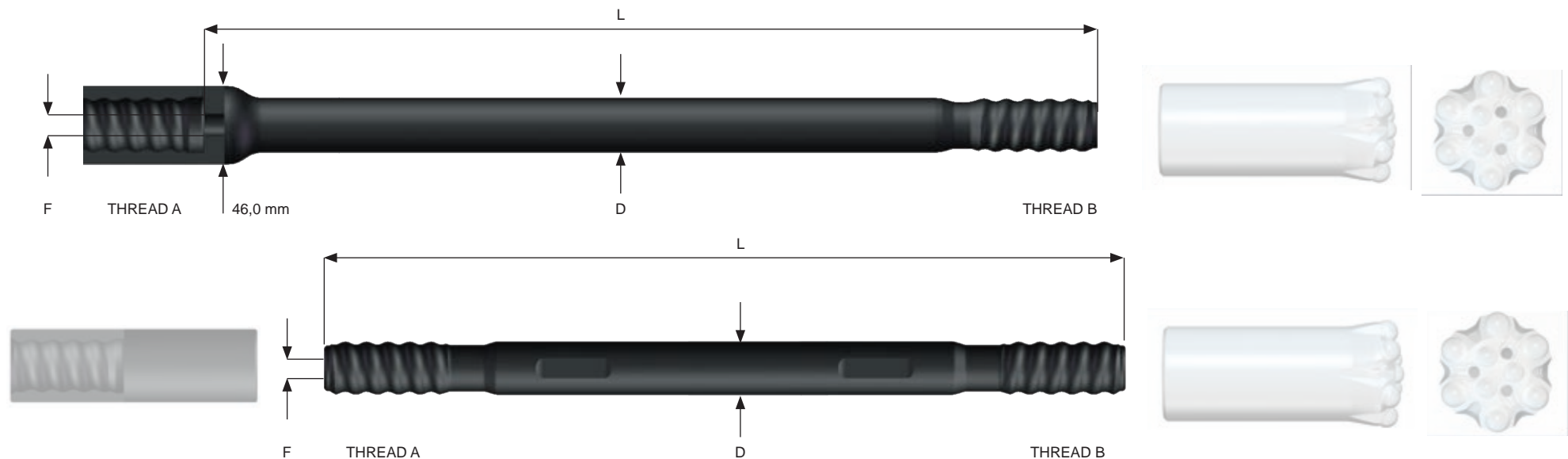









Surface
Drilling

C38 **Rbit™** CONSISTENT HIGH QUALITY

1 ½" thread

C38 (1 ½") - threads

Order code	Diameter		Body	Gauge	Buttons				Flushing		Product number		Weight [kg]	Pcs/box
	[mm]	[in]			[No.]	[mm]	[No.]	[mm]	[No.]	[No.]	[No.]	[Hemispherical]		
TH RBIT 38C064FF	64	2 ½"		35°	4 x 9	8 x 10	3	-	01-238-064-2244	01-238-064-2245	1,7	4		
TH RBIT 38C064FFR HD	64	2 ½"		35°	4 x 10	8 x 11	3	-	01-238-064-2271	01-238-064-2272	1,9	4		
TH RBIT 38C064DC HD	64	2 ½"		35°	5 x 9	8 x 10	5	-	2000452*	2000453	1,6	4		
TH RBIT 38C064DCR HD	64	2 ½"		35°	5 x 9	8 x 10	5	-	01-238-064-0864*	01-238-064-0865*	1,9	4		
TH RBIT 38C070DCR	70	2 ¾"		35°	5 x 10	8 x 10	5	-	2000689	2000690	2,7	4		
TH RBIT 38C076FF	76	3"		35°	5 x 10	9 x 10	4	-	01-238-076-2048	01-238-076-2049	2,3	4		
TH RBIT 38C076FFR	76	3"		35°	5 x 10	9 x 10	4	-	01-238-076-2157	01-238-076-2158	3,3	4		
TH RBIT 38C076DC	76	3"		35°	5 x 11	8 x 11	5	-	2000449	2000450	2,4	4		
TH RBIT 38C076DCR	76	3"		35°	5 x 11	8 x 11	5	-	2000446	2000447*	3,2	4		

*Best seller



38C064FF



38C064FFR HD



38C064DC HD



38C064DCR HD
38C070DCR
38C076DCR



38C076FF



38C076FFR



38C076DC

Extension Rod (Male/Female & Male/Male) - C38 (1 1/2") bit thread

Order code	Length		Diameter D [mm]	Thread		Flushing F [mm]	Product number	Weight [kg]	Pcs/box 
	L [mm]	[ft - in]		[A]	[B]				

Extension M/F Rod C38 - round 39 - C38

TH Rod M/F C38 39R 3050	3050	10'	RND39	C38	C38	14,5	06B-07-2199	25,6	24
TH Rod M/F C38 39R 3660	3660	12'	RND39	C38	C38	14,5	06B-07-2491	30,4	24
TH Rod M/F C38 39R 4265	4265	14'	RND39	C38	C38	14,5	06B-07-3243	35,2	24

Extension M/M Rod C38 - round 39 - C38

TH Rod M/M C38 39R 3050	3050	10'	RND39	C38	C38	14,5	06A-07-0492	24,3	50
TH Rod M/M C38 39R 3660	3660	12'	RND39	C38	C38	14,5	06A-07-0491	29,2	40

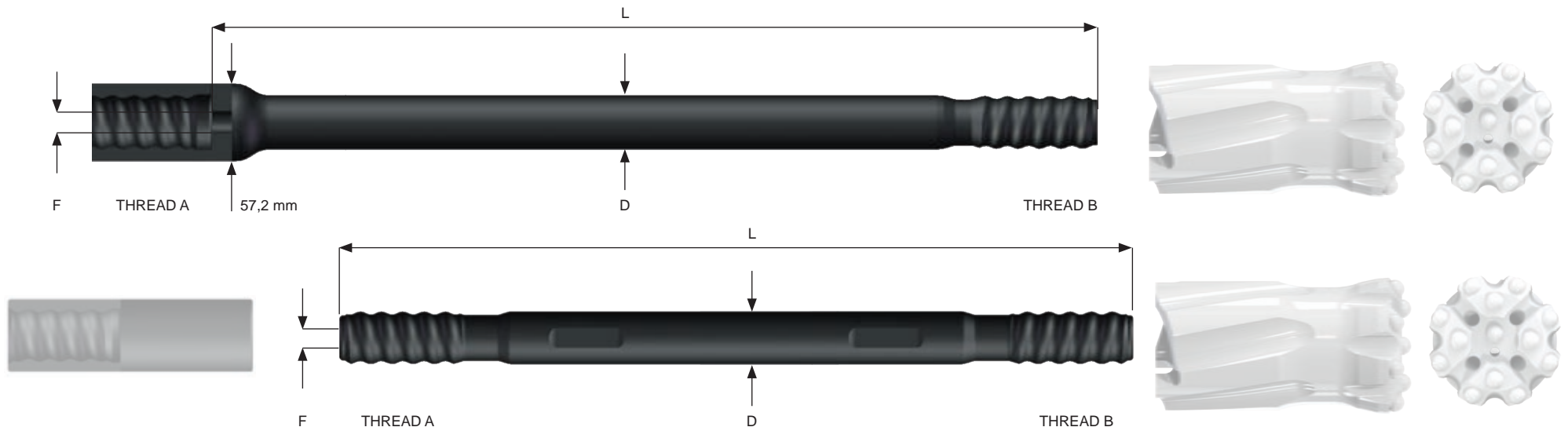









Surface
Drilling

C45 **Rbit™** CONSISTENT HIGH QUALITY

1 3/4" thread

C45 (1 3/4") - threads

Order code	Diameter		Body	Gauge	Buttons				Flushing		Product number		Weight [kg]	Pcs/box
	[mm]	[in]			[No.]	[mm]	[No.]	[mm]	[No.]	[No.]	[No.]	[Hemispherical]		
TH RBIT 45C070DCR	70	2 3/4"		35°	5 x 10	8 x 10	5	-	2000695	2000696*	2,5	4		
TH RBIT 45C076FF	76	3"		35°	5 x 10	9 x 10	4	-	01-245-076-2350*	01-245-076-2351	2,7	4		
TH RBIT 45C076FFR HD	76	3"		35°	5 x 10	9 x 11	4	-	01-245-076-2283	01-245-076-2284	2,9	4		
TH RBIT 45C76DC	76	3"		35°	5 x 11	8 x 11	5	-	2000443*	2000444*	2,7	4		
TH RBIT 45C076DCR	76	3"		35°	5 x 11	8 x 11	5	-	01-245-076-0398*	01-245-076-0866*	2,9	4		
TH RBIT 45C089DC	89	3 1/2"		35°	5 x 12	8 x 12	5	-	2000363*	2000364*	3,4	2		
TH RBIT 45C089DCR	89	3 1/2"		35°	5 x 12	8 x 12	5	-	2000113*	2000114*	4,7	2		
TH RBIT 45C089FF	89	3 1/2"		35°	6 x 11	9 x 12	4	-	01-245-089-1169	01-245-089-1172	3,4	2		
TH RBIT 45C089FFR	89	3 1/2"		35°	6 x 11	9 x 12	4	-	01-245-089-1176	01-245-089-1180	4,7	2		

*Best seller



45C070DCR
45C076DCR
45C089DCR



45C076FF
45C089FF



45C076FFR HD
45C089FFR



45C076DC



45C089DC

C45 RODS - CONSISTENT HIGH QUALITY

1 3/4" thread

Extension Rod (Male/Female) - C45 (1 3/4") bit thread

Order code	Length		Diameter D [mm]	Thread		Flushing F [mm]	Product number	Weight [kg]	Pcs/box 
	L [mm]	[ft - in]		[A]	[B]				
Extension M/F Rod C45 - round 46 - C45									
TH Rod M/F C45 46R 3050	3050	10'	RND46	C45	C45	17,0	06B-07-2882	35,7	24
TH Rod M/F C45 46R 3660	3660	12'	RND46	C45	C45	17,0	06B-07-0501	42,5	24
TH Rod M/F C45 46R 4265	4265	14'	RND46	C45	C45	17,0	06B-07-2912	49,5	24
TH Rod M/F C45 46R 6095	6095	20'	RND46	C45	C45	17,0	06B-07-3244	69,0	16



Extension Rod (Male/Male) - C45 (1 3/4") bit thread

Order code	Length		Diameter	Thread		Flushing	Product number	Weight	Pcs/box
	L			D	[A]				
	[mm]	[ft - in]	[mm]			[mm]		[kg]	
Extension M/M Rod C45 - round 46 - C45									
TH Rod M/M C45 46R 3050	3050	10'	RND46	C45	C45	17,0	06A-07-0489	33,6	30
TH Rod M/M C45 46R 3660	3660	12'	RND46	C45	C45	17,0	06A-07-2905	40,4	30
TH Rod M/M C45 46R 4265	4265	14'	RND46	C45	C45	17,0	06A-07-2906	47,1	25

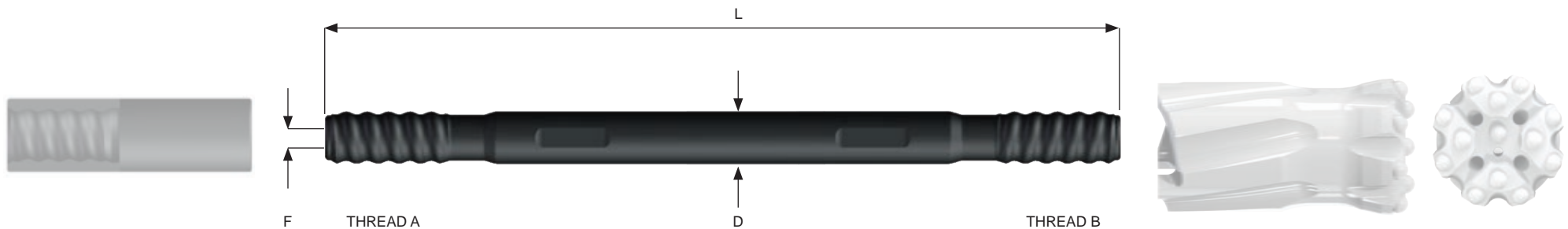









C51

2" thread

Robit™ CONSISTENT HIGH QUALITY

C51 (2'') - threads

Order code	Diameter		Body	Gauge	Buttons				Flushing		Product number		Weight [kg]	Pcs/box
	[mm]	[in]			[No.]	[mm]	[No.]	[mm]	[No.]	[No.]	[No.]	[Hemispherical]		
TH RBIT 51C083FFR HD	83	3 ¼"		35°	6 x 11	9 x 13	4	-	2001699	2001700	3,4	2		
TH RBIT 51C083DCR	83	3 ¼"		35°	5 x 12	8 x 12	5	-	2000158*	2000159*	3,4	2		
TH RBIT 51C089FF HD	89	3 ½"		35°	6 x 12	9 x 13	4	-	01-251-089-1247*	01-251-089-1249	3,8	2		
TH RBIT 51C089FFR	89	3 ½"		35°	6 x 11	9 x 12	4	-	01-251-089-1240*	01-251-089-1243	4,3	2		
TH RBIT 51C089DC	89	3 ½"		35°	5 x 12	8 x 12	5	-	2000037*	2000038	3,7	2		
TH RBIT 51C089DCR	89	3 ½"		35°	5 x 12	8 x 12	5	-	01-251-089-0877*	01-251-089-0878*	4,3	2		
TH RBIT 51C102FF	102	4"		35°	6 x 13	9 x 13	4	-	01-251-102-2063	01-251-102-2064	4,6	1		
TH RBIT 51C102FFR	102	4"		35°	6 x 13	9 x 13	4	-	01-251-102-2559	01-251-102-2732	6,2	1		
TH RBIT 51C102DC HD	102	4"		35°	5 x 14	8 x 14	5	-	01-251-102-0868*	01-251-102-0869	4,6	1		

*Best seller



51C083FFR HD
51C089FFR
51C102FFR



51C083DCR
51C089DCR







51C089FF HD



51C089DC
51C102DC HD

C51 (2") - threads

Order code	Diameter		Body	Gauge	Buttons				Flushing		Product number		Weight [kg]	Pcs/box
	[mm]	[in]			[No.]	[mm]	[No.]	[mm]	[No.]	[No.]	[Hemispherical]	[Semi-Ballistic]		
TH RBIT 51C102DCR HD	102	4"		35°	5 x 14	8 x 14	5	-	2000103*	2000104*	6,3	1		
TH RBIT 51C115FF	115	4 ½"		35°	7 x 14	9 x 14	4	-	01-251-115-2110	01-251-115-2111	5,8	1		
TH RBIT 51C115FFR	115	4 ½"		35°	7 x 14	9 x 14	4	-	01-251-115-2346	01-251-115-2347*	8,1	1		
TH RBIT 51C115DC	115	4 ½"		35°	2 x 12 4 x 14	8 x 14	5	-	2000345	2000346	5,6	1		
TH RBIT 51C115DCR	115	4 ½"		35°	2 x 12 4 x 14	8 x 14	5	-	2000356*	2000357	8,0	1		

*Best seller

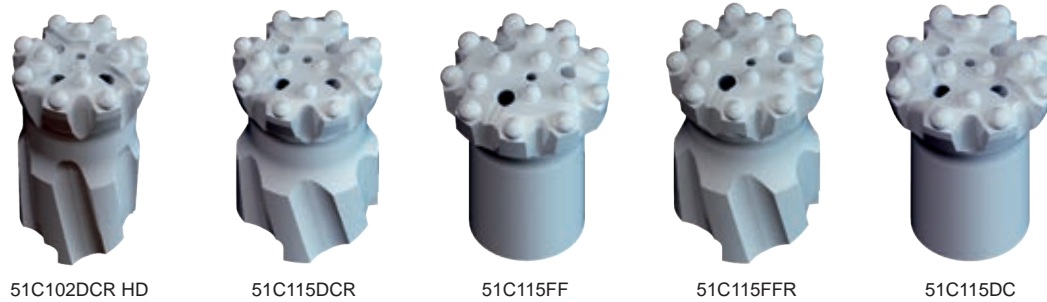

C51

2" thread

RODS - CONSISTENT HIGH QUALITY

Extension Rod (Male/Female) - C51 (2") bit thread

Order code	Length		Diameter D [mm]	Thread		Flushing F [mm]	Product number	Weight [kg]	Pcs/box 
	L [mm]	[ft - in]		[A]	[B]				
Extension M/F Rod C51 - round 52 - C51									
TH Rod M/F C51 52R 3660	3660	12'	RND52	C51	C51	21,5	06B-07-0500	52,5	18
TH Rod M/F C51 52R 4265	4265	14'	RND52	C51	C51	21,5	06B-07-2884	61,0	18
TH Rod M/F C51 52R 6095	6095	20'	RND52	C51	C51	21,5	06B-07-3245	85,6	12

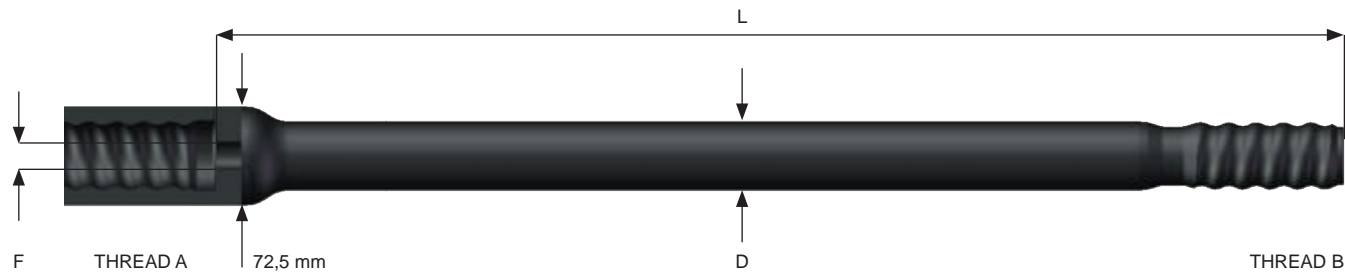

Extension Rod (Male/Male) - C51 (2") bit thread

Order code	Length		Diameter D [mm]	Thread		Flushing F [mm]	Product number	Weight [kg]	Pcs/box 
	L [mm]	[ft - in]		[A]	[B]				
Extension M/M Rod C51 - round 52 - C51									
TH Rod M/M C51 52R 3660	3660	12'	RND52	C51	C51	21,5	06A-07-2536	49,8	25
TH Rod M/M C51 52R 4265	4265	14'	RND52	C51	C51	21,5	06A-07-2909	58,1	20
TH Rod M/M C51 52R 6095	6095	20'	RND52	C51	C51	21,5	06A-07-3246	83,5	15

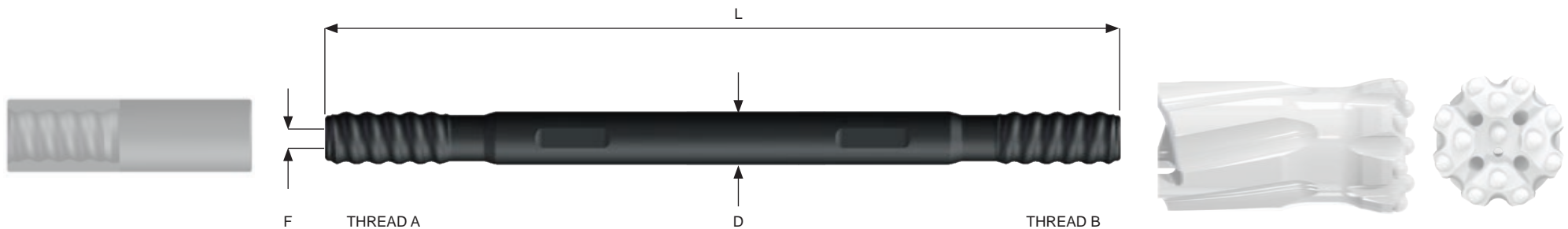

Surface
Drilling

RG60 Rbit™ CONSISTENT HIGH QUALITY

2 1/3" thread

RG60 (2 1/3") - threads

Order code	Diameter		Body	Gauge	Buttons				Flushing		Product number		Weight [kg]	Pcs/box
	[mm]	[in]			⌘	[No.]	[mm]	[No.]	[mm]	[No.]	[No.]	[No.]		
TH RBIT 60RG102FFR	102	4"		35°	6 x 13	9 x 13	4	-	01-460-102-2204	01-460-102-2205*	7,6	1		
TH RBIT 60RG102DC HD	102	4"		35°	5 x 14	8 x 14	5	-	2000408*	2000409	7,0	1		
TH RBIT 60RG102DCR HD	102	4"		35°	5 x 14	8 x 14	5	-	2000110	2000111	7,5	1		
TH RBIT 60RG115FF	115	4 1/2"		35°	7 x 14	9 x 14	4	-	01-460-115-2564*	01-460-115-3397	8,5	1		
TH RBIT 60RG115FFR	115	4 1/2"		35°	7 x 14	9 x 14	4	-	01-460-115-2566	01-460-115-3398*	9,5	1		
TH RBIT 60RG115FFR HD	115	4 1/2"		35°	6 x 14	9 x 16	4	-	01-460-115-5606*	01-460-115-5607	9,5	1		
TH RBIT 60RG115DCR	115	4 1/2"		35°	2 x 12 4 x 14	8 x 14	5	-	2000432*	2000433	9,5	1		
TH RBIT 60RG127FF	127	5"		35°	8 x 14	9 x 14	4	-	01-460-127-2568	01-460-127-3035	8,8	1		
TH RBIT 60RG127FFR	127	5"		35°	8 x 14	9 x 14	4	-	01-460-127-2570	01-460-127-3037	11,0	1		
TH RBIT 60RG127DCR HD	127	5"		35°	2 x 14	10 x 16	6	-	2000709*	2000710	11,0	1		
TH RBIT 60RG140FF HD	140	5 1/2"		35°	10 x 14	12 x 16	4	-	2001550*	2001551	12,2	1		
TH RBIT 60RG140DCR HD	140	5 1/2"		35°	3 x 14 5 x 16	10 x 16	6	-	2000536	2000537	14,7	1		

*Best seller

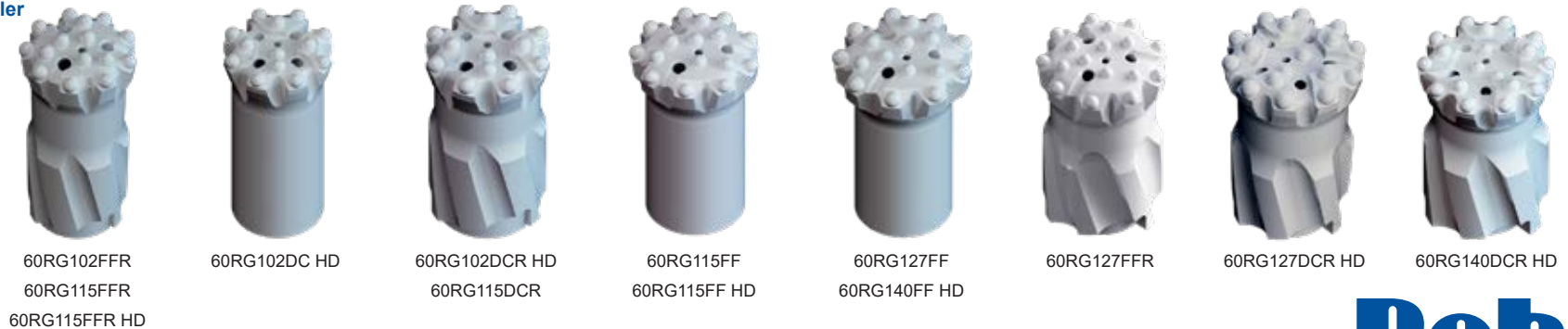

TOP PERFORMANCE - RODS RG60

2 1/3" thread

Extension Rod (Male/Female) - RG60 (2 1/3") bit thread

Order code	Length		Diameter D [mm]	Thread		Flushing F [mm]	Product number	Weight [kg]	Pcs/box 
	L [mm]	[ft - in]		[A]	[B]				

Extension M/F Rod RG60 - round 60 - RG60 (for bits from 96 mm)

TH Rod M/F RG60 60R 3660	3660	12'	RND60	RG60	RG60	22,5	06B-07-3358	74,1	12
TH Rod M/F RG60 60R 4265	4265	14'	RND60	RG60	RG60	22,5	06B-07-0502	85,7	12
TH Rod M/F RG60 60R 6095	6095	20'	RND60	RG60	RG60	22,5	06B-07-3359	120,5	10



Surface
Drilling

C38, C45 & C51 GUIDE TUBES - CONSISTENT HIGH QUALITY

1 1/2", 1 3/4", 2" thread

C38, C45 & C51 (1 1/2", 1 3/4", 2") . threads

Order code	Length		Diameter		Thread		Flushing	Product number	Weight [kg]	Pcs/box 
	L		D				F			
	[mm]	[ft - in]	[mm]	[A]	[B]	[mm]				
TH Guide Tube M/F C38 56T 3660	3660	12'	56	C38	C38	14,5	3000116	45,2	24	
TH Guide Tube M/F C45 65T 3660	3660	12'	65	C45	C45	18	3000118	62,8	24	
TH Guide Tube M/F C51 76T 3660	3660	12'	76	C51	C51	22	3000120	78,7	18	

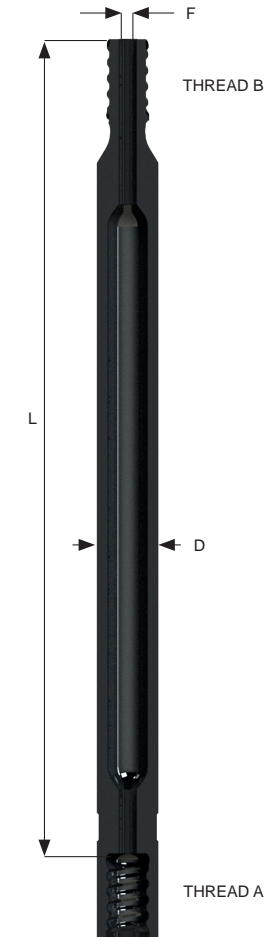

SHANK ADAPTERS



SHANK ADAPTERS

Compatible with the drifter of manufacturer:

Epiroc · Furukawa · Gardner Denver · Ingersoll Rand · Montabert · Sandvik





SHANK ADAPTERS

Index

Epiroc

BBC 51, 52, 54, 120	79
BBE 57, 5701	79
COP MD20	79
COP 125, 130, 131	79
COP 1036, 1038 HD/HB, 1238	80
COP 1038 HL, 1238	80
COP 1132	80
COP 1140, 1435	80
COP 1432, 1440, 1532, 1550, 1638, 1838, 2238	81
COP 1440, 1550, 1838	81
COP 1550 EX, 1838 EX	81
COP 1838MUX/HUX	82
COP 1240, 1640, 1840HE	82
COP 1240EX, 1640EX, 1840EX, 1850EX, 2150EX, 2540EX, 2550EX	82
COP 2150, 2550	82
COP 2160, 2560	83
COP 2160 EX, 2560 EX	83
COP 2550UX	83
COP 2560EX+	84
COP 3038HE	84
COP 3060ME	84
COP 3060MEX	84
COP 3060MUX	85
COP 4050MUX	85

Furukawa

HD 300	86
HD 609	86
HD 612	86

HD 709	86
HD 709RP	87
HD 712	87
HD 712RP	87
HD 715	87
HD 715RP	88
HD 836	88
PD 200, M 120	88

Gardner Denver

HPR 2	89
HPR 5123	89

Ingersoll Rand

HYD 200 Female	90
YH 65, 70, 80	90
YH 70A	90
YH 65RP, 70RP, 80RP	90
YH 80A	91
YH 110V, 124, 135	91

Montabert

HC 20 Female	92
HC 25 Female	92
HC 40 Female	92
HC 40, 50	92
HC 40, 50	93
HC 80, 90, 105	93
HC 80RP	93
HC 95RP	93

HC 95RP	94
HC 110	94
HC 120, 150	94
HC 120RP, 150RP	94
HC 160, 170	95
HC 200	95

Sandvik

HL 300	96
L 400, 410, 500, 510, 550	96
HL 300S Female	96
RD 314 Female	96
RD 314	97
HL 500S, 510S	97
HL 500, 510, 510S, 550S, 560S	97
HLX 5, 5T, RDX 5	97
RD 520, 525	98
HL 600, 600S	98
HL 650, 700, 800T	98
HL 650, 700, 800T	99
RD 900PE	99
HL 1000, 1000S, 1010, 1010S	99
HL 1000, 1010	100
HL 1000 PE, 1010 PE, 1060T, 1060T PE, 1560T, 1560T PE	100
HL 1060T, 1500T, 1560T	100
HL 1500, 1500T	100
HL 1500	101
HL 1500T PE-90	101

SHANK ADAPTERS for drifters of EPIROC

BBC
BBE
COP

Flushing	Thread	Length L	Diameter D	Product number	Weight
[mm]		[mm]	[mm]		[kg]

BBC 51, 52, 54, 120

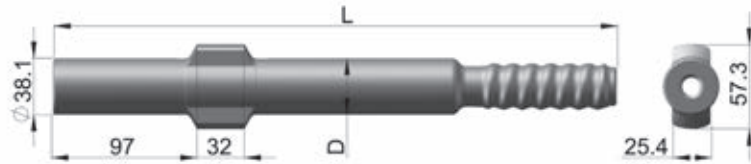

10	R32	380	38	06F-07-3188	2,6
10	C38	390	38	06F-07-3189	3,1

BBE 57, 5701

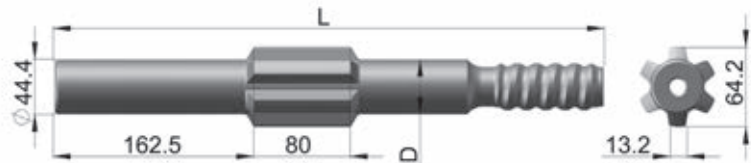

14	C38	538	44	06F-07-3190	5,3
----	-----	-----	----	-------------	-----

COP MD20

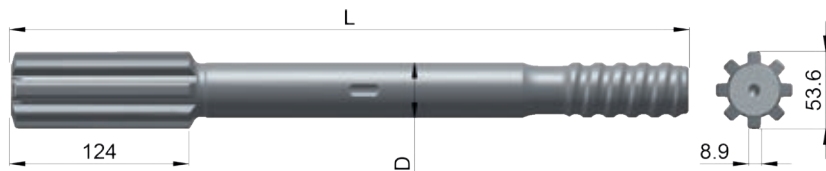

-	C38	470	38	3000047	4,4
---	-----	-----	----	---------	-----

COP 125, 130, 131



14	C38	380	38	06F-07-3191	3,0
----	-----	-----	----	-------------	-----

COP SHANK ADAPTERS for drifters of EPIROC

COP 1036, 1038 HD/HB, 1238



COP 1038 HL, 1238



COP 1132



COP 1140, 1435



Flushing	Thread	Length	Diameter	Product number	Weight
[mm]		L [mm]	D [mm]		[kg]
-	R38	485	38	06F-07-2720	4,2
-	C38	485	38	06F-07-2430	4,2
-	R32	500	38	06F-07-2820	4,0
-	C38	500	38	06F-07-2822	4,4
-	C45	500	45	06F-07-2823	5,0
-	C38	575	38	06F-07-2829	4,9
-	C38	575	45	06F-07-2833	4,9
-	C45	575	45	06F-07-2834	5,8
-	R32	410	35	06F-07-3118	2,5
-	R32	500	35	3000019	3,1
-	R32	410	35	3000038	2,8

SHANK ADAPTERS for drifters of EPIROC

COP

COP 1432, 1440, 1532, 1550, 1638, 1838, 2238



Flushing	Thread	Length L [mm]	Diameter D [mm]	Product number	Weight [kg]
-	R32	435	38	06F-07-2431	3,6
-	R38	435	38	06F-07-2719	3,9
-	C38	435	38	06F-07-0487	3,9

COP 1432, 1440, 1532, 1550, 1638, 1838, 2238



-	R32	525	38	06F-07-2432	4,0
-	R38	525	38	06F-07-2835	4,7
-	C38	525	38	06F-07-2662	4,4

COP 1440, 1550, 1838

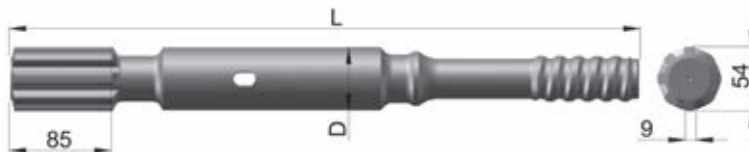

-	C38	525	52	06F-07-2838	5,9
-	C45	525	52	06F-07-2337	6,2
-	C51	525	52	06F-07-2839	6,8

COP 1550 EX, 1838 EX

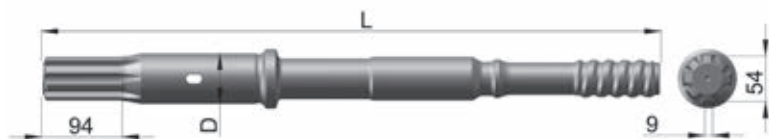

-	C38	730	60	06F-07-3196	9,8
-	C45	730	60	06F-07-3197	10,2

COP SHANK ADAPTERS for drifters of EPIROC

COP 1838MUX/HUX

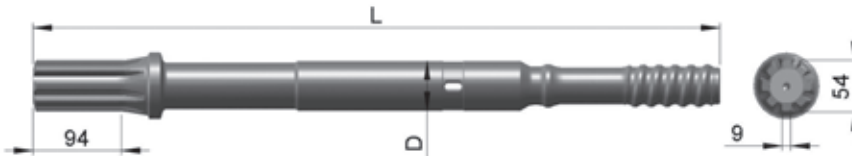

Flushing	Thread	Length	Diameter	Product number	Weight
[mm]		L [mm]	D [mm]		[kg]

-	C38	730	52	06F-07-6980	9,6
-	C45	730	52	06F-07-6553	9,9

COP 1240, 1640, 1840HE



-	C38	565	52	06F-07-2840	7,5
-	C45	565	52	06F-07-2841	6,9
-	C51	565	52	06F-07-0472	7,1

COP 1240EX, 1640EX, 1840EX, 1850EX, 2150EX, 2540EX, 2550EX



-	C38	770	60	06F-07-4685	10,0
-	C45	770	60	06F-07-2740	10,9
-	C51	770	60	06F-07-3373	11,2

COP 2150, 2550



-	C51	770	52	06F-07-3374	9,9
---	-----	-----	----	-------------	-----

SHANK ADAPTERS for drifters of EPIROC

COP

COP 2160, 2560



Flushing	Thread	Length L [mm]	Diameter D [mm]	Product number	Weight [kg]
-	C45	770	60	06F-07-6890	11,6
-	C51	770	60	06F-07-6499	12,1

COP 2160 EX, 2560 EX



-	C45	770	63	06F-07-3375	13,3
-	C51	770	63	06F-07-3376	13,5

COP 2550UX

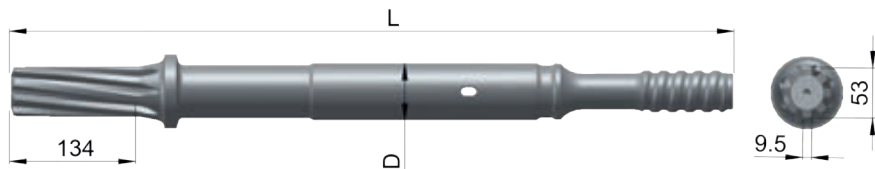

-	C45	770	60	3000138	12,8
---	-----	-----	----	---------	------

COP 2550UX

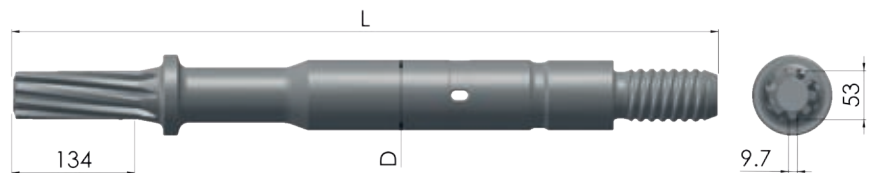

-	CT58	770	77	3000099	19,4
---	------	-----	----	---------	------

COP SHANK ADAPTERS for drifters of EPIROC

COP 2560EX+



COP 3038HE

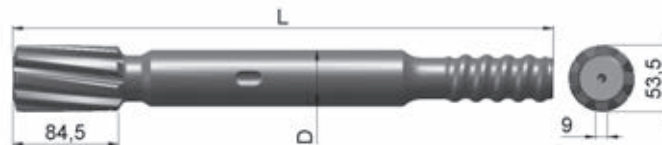

COP 3060ME



COP 3060MEX

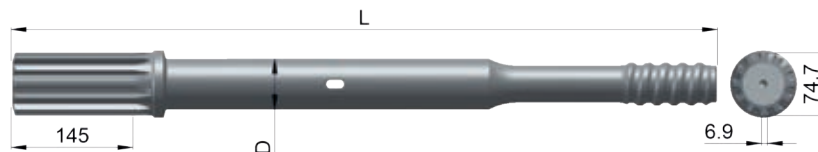

Flushing	Thread	Length L	Diameter D	Product number	Weight
[mm]		[mm]	[mm]		[kg]

-	C45	770	63	3000024	13,2
-	C51	770	63	06F-07-0900	14,0

-	C38	435	45	06F-07-5752	4,5
---	-----	-----	----	-------------	-----

-	RG60	840	60	3000269	16,4
---	------	-----	----	---------	------

-	C51	840	60	3000172	15,9
-	RG60	840	60	06F-07-6407	17,0

SHANK ADAPTERS for drifters of EPIROC

COP

COP 3060MUX

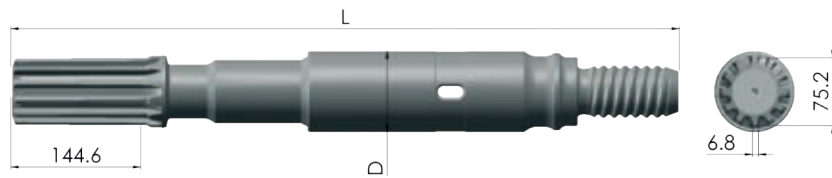

COP 4050MUX

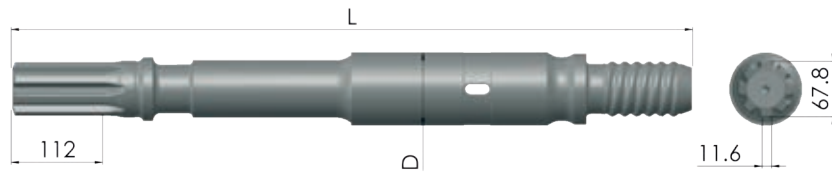

Flushing	Thread	Length L	Diameter D	Product number	Weight
[mm]		[mm]	[mm]		[kg]
-	CT58	745	90	3000206	23,8
-	CT68	745	90	3000207	24,5

-	CT68	835	90	2000771	26,8
---	------	-----	----	---------	------

HD

SHANK ADAPTERS for drifters of FURUKAWA

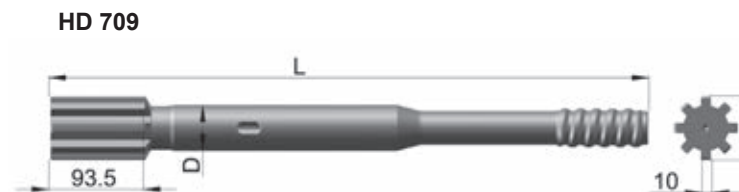
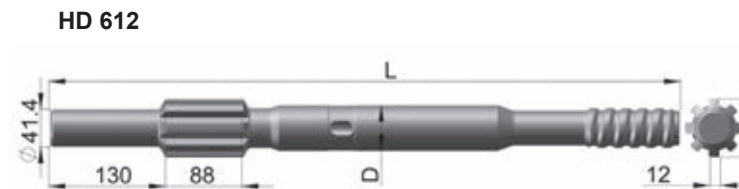
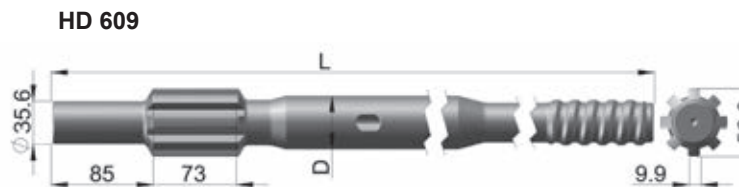
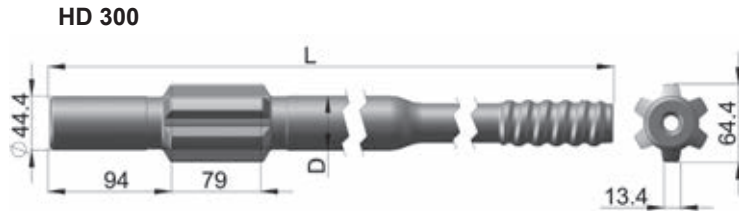

Flushing	Thread	Length L	Diameter D	Product number	Weight
[mm]		[mm]	[mm]		[kg]

16	C38	655	45	06F-07-3200	6,2
16	C45	655	45	06F-07-3201	6,5

-	C38	620	45	06F-07-2844	6,0
-	C45	620	45	06F-07-2845	6,6
-	C38	690	45	06F-07-3202	6,4
-	C45	690	45	06F-07-4952	6,8

-	C45	710	51	06F-07-2742	8,7
-	C51	710	51	06F-07-4562	9,2

-	C38	590	45	06F-07-4968	6,0
-	C45	590	45	06F-07-4969	6,4
-	C38	620	45	06F-07-2846	6,4
-	C45	620	45	06F-07-4400	6,7

SHANK ADAPTERS for drifters of FURUKAWA

HD

HD 709RP



Flushing	Thread	Length L	Diameter D	Product number	Weight
[mm]		[mm]	[mm]		[kg]
-	C38	785	45	06F-07-4970	9,2
-	C45	785	45	06F-07-0486	9,5
-	C38	815	45	06F-07-4971	9,3
-	C45	815	45	06F-07-0485	9,6

HD 712



-	C45	590	51	06F-07-4972	8,7
-	C51	590	51	06F-07-4973	8,8
-	C45	790	51	06F-07-2200	10,5
-	C51	790	51	06F-07-4564	10,9

HD 712RP



-	C45	785	51	06F-07-4976	10,0
-	C51	785	51	06F-07-4978	11,0
-	C45	885	51	06F-07-4977	12,5
-	C51	885	51	06F-07-0484	13,5

HD 715



-	C51	790	58	06F-07-4109	12,5
---	-----	-----	----	-------------	------

HD
PD

SHANK ADAPTERS for drifters of **FURUKAWA**

HD 715RP



HD 836



PD 200, M 120



Flushing	Thread	Length	Diameter	Product number	Weight
[mm]		L [mm]	D [mm]		[kg]

-	C45	885	58	06F-07-4981	14,4
-	C51	885	58	06F-07-3872	15,9

-	RG60	794	68	3000178	16,7
---	------	-----	----	---------	------

14	R32	380	44	06F-07-3377	3,4
14	C38	380	44	06F-07-3199	3,7
14	C38	446	44	06F-07-0480	4,5

SHANK ADAPTERS for drifters of **GARDNER DENVER** HPR

Flushing	Thread	Length L	Diameter D	Product number	Weight
[mm]		[mm]	[mm]		[kg]

HPR 2

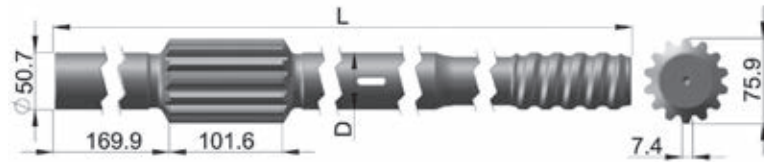

-	C51	914	51	06F-07-4362	14,1
---	-----	-----	----	-------------	------

HPR 5123

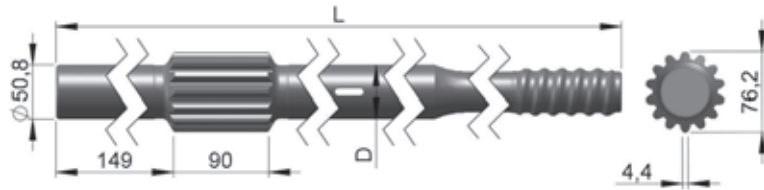

-	C51	770	51	06F-07-5965	12,0
---	-----	-----	----	-------------	------

HYD
YH

SHANK ADAPTERS for drifters of **INGERSOLL RAND**

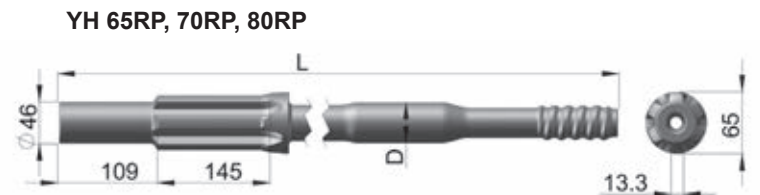
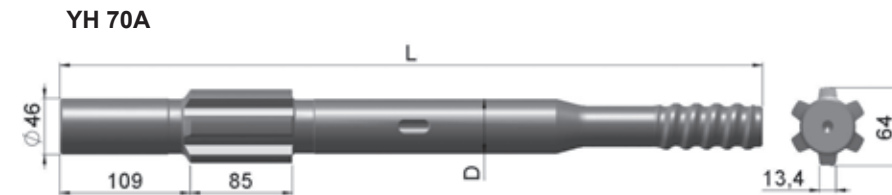
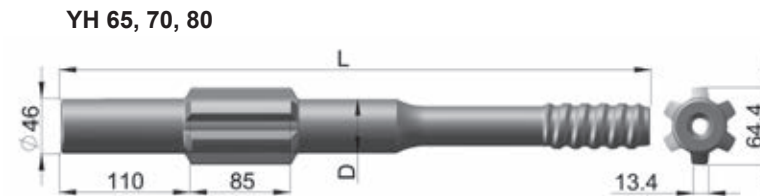
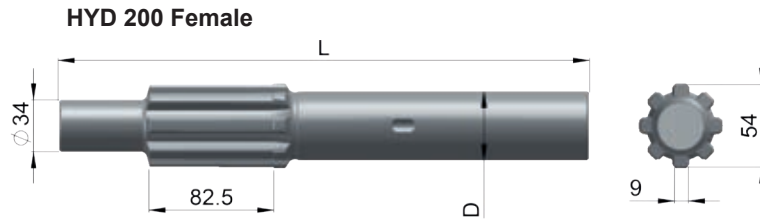

Flushing	Thread	Length L	Diameter D	Product number	Weight
[mm]		[mm]	[mm]		[kg]
-	R32	351	45	06F-07-3428	3,8
19	C38	495	45	06F-07-0476	5,0
19	C45	495	45	06F-07-2713	5,4
12	C38	580	45	06F-07-5053	5,5
12	C45	580	45	06F-07-5054	5,5
15	C45	610	45	06F-07-5616	6,8
15	C38	613	45	06F-07-6321	6,2
-	C38	585	45	06F-07-6254	6,8
19	C45	700	45	06F-07-4450	8,0
13	C38	820	45	06F-07-5302	9,0
13	C45	820	45	06F-07-5301	9,0

SHANK ADAPTERS for drifters of **INGERSOLL RAND**

YH

YH 80A



Flushing	Thread	Length L [mm]	Diameter D [mm]	Product number	Weight [kg]
19	C45	495	51	06F-07-2714	5,9
19	C45	638	51	06F-07-6325	7,8
19	C51	638	51	06F-07-5382	7,9

YH 110V, 124, 135

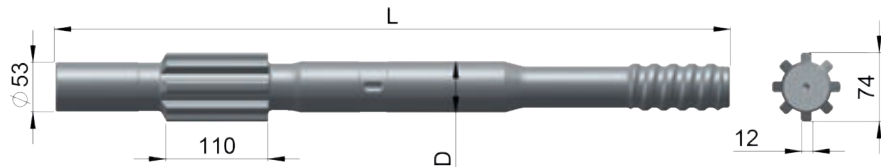

-	C51	728	55	06F-07-5290	13,6
-	C51	890	55	06F-07-5384	13,7

SHANK ADAPTERS for drifters of MONTABERT

HC 20 Female



HC 25 Female



HC 40 Female

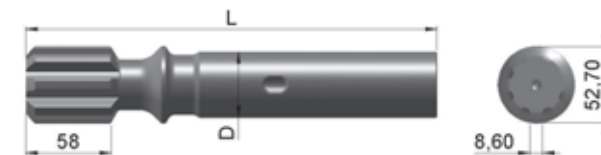

HC 40, 50



Flushing	Thread	Length	Diameter	Product number	Weight
[mm]		L [mm]	D [mm]		[kg]
-	R32	187	45	06F-07-5035	1,8
-	R32	202	45	06F-07-5036	2,0
-	R32	270	45	06F-07-3380	2,8
-	R32	372	38	06F-07-6806	3,4
-	C38	372	38	3000018	3,5
-	R38	381	38	06F-07-5637	3,7
-	R32	388	38	06F-07-7037	3,5

SHANK ADAPTERS for drifters of MONTABERT

HC

HC 40, 50



Flushing	Thread	Length L [mm]	Diameter D [mm]	Product number	Weight [kg]
-	C38	438	38	06F-07-7036	3,6
-	R32	440	38	06F-07-7038	3,5
-	R32	447	38	06F-07-2741	3,5
-	C38	447	38	06F-07-4336	4,0

HC 80, 90, 105

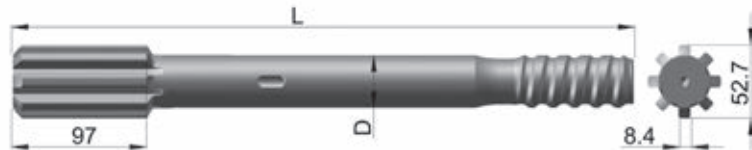

-	R32	440	38	06F-07-4988	3,6
-	R38	440	38	06F-07-2144	3,9
-	C38	440	38	06F-07-4955	3,9
-	C38	450	38	06F-07-2434	4,0
-	C38	508	38	06F-07-3381	4,2

HC 80RP

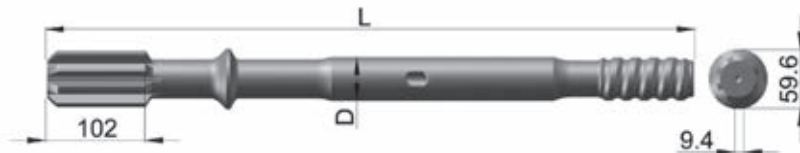

-	C38	670	45	06F-07-4337	7,2
-	C45	670	45	06F-07-2715	7,9

HC 95RP



-	R38	503	45	3000011	6,0
-	C38	503	45	06F-07-6557	6,5

SHANK ADAPTERS for drifters of MONTABERT

HC 95RP

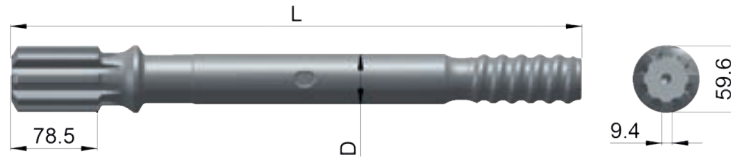

Flushing	Thread	Length	Diameter	Product number	Weight
[mm]		L [mm]	D [mm]		[kg]

-	R32	503	45	3000032	5,7
-	C38	503	45	3000033	6,0

HC 110



-	C38	415	45	06F-07-3572	4,6
-	C45	425	45	06F-07-3573	5,0

HC 120, 150

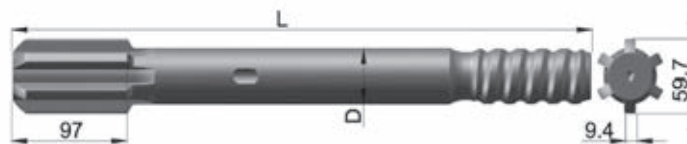

-	C38	490	45	06F-07-5163	5,4
-	C45	490	45	06F-07-3204	5,8

HC 120RP, 150RP



-	C45	670	51	06F-07-4989	8,6
-	C51	670	51	06F-07-2032	9,3

SHANK ADAPTERS for drifters of MONTABERT

HC

Flushing	Thread	Length L	Diameter D	Product number	Weight
[mm]		[mm]	[mm]		[kg]

HC 160, 170

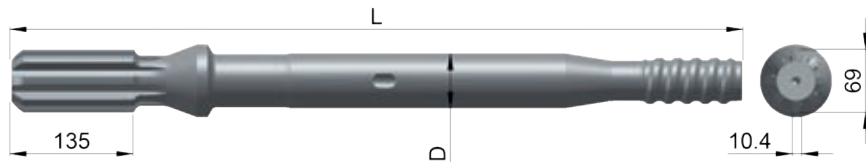

-	C51	807	60	06F-07-3157	15,0
---	-----	-----	----	-------------	------

HC 200



-	C51	840	51	06F-07-2743	13,6
---	-----	-----	----	-------------	------

HL
L
RD

SHANK ADAPTERS for drifters of SANDVIK

Flushing	Thread	Length L	Diameter D	Product number	Weight
[mm]		[mm]	[mm]		[kg]



-	R32	400	32	06F-07-2771	2,6
---	-----	-----	----	-------------	-----

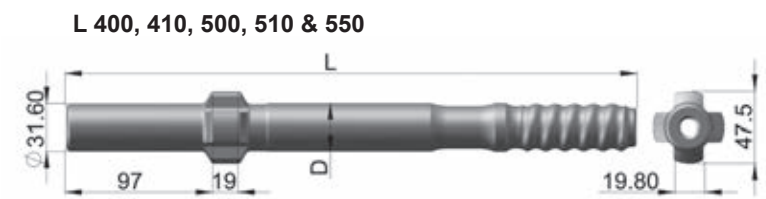

-	R32	380	32	06F-07-2776	2,0
---	-----	-----	----	-------------	-----

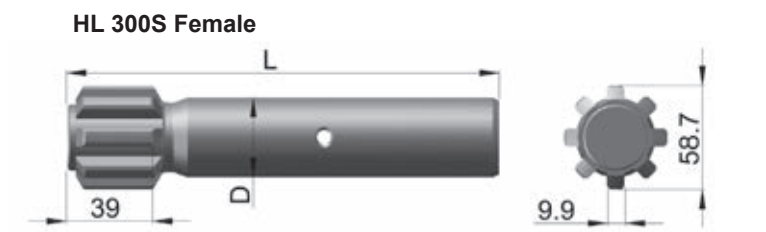

-	R32	245	45	06F-07-2198	2,6
---	-----	-----	----	-------------	-----

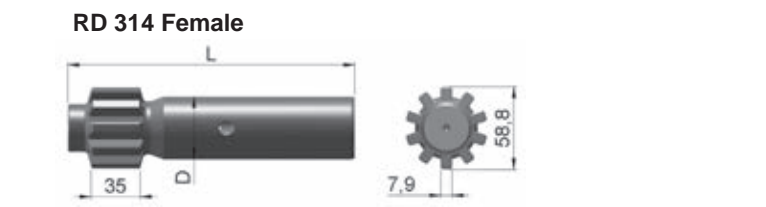

-	R32	205	45	06F-07-4920	2,0
---	-----	-----	----	-------------	-----

SHANK ADAPTERS for drifters of SANDVIK

RD
HL
HLX
RDX

RD 314



Flushing	Thread	Length L [mm]	Diameter D [mm]	Product number	Weight [kg]
-	R32	410	38	3000197	3,3

HL 500S, 510S



-	R32	460	38	06F-07-2335	3,7
-	R38	460	38	06F-07-2721	3,9
-	C38	460	38	06F-07-2371	4,0
-	R38	500	38	06F-07-2787	3,9
-	C38	500	38	06F-07-2788	4,0

HL 500, 510, 510S, 550S, 560S



-	R38	500	45	06F-07-2789	5,3
-	C38	500	45	06F-07-2790	5,3
-	R32	550	45	06F-07-2494	5,3
-	C38	550	45	06F-07-0483	5,3
-	C45	550	45	06F-07-2527	5,8

HLX 5, 5T, RDX 5



-	R32	500	45	06F-07-2791	5,1
-	R38	500	45	06F-07-2792	5,4
-	C38	500	45	06F-07-2334	5,4
-	R32	575	45	06F-07-2793	5,5
-	C38	575	45	06F-07-2795	6,0
-	C45	575	45	06F-07-4837	5,8

SHANK ADAPTERS for drifters of SANDVIK

RD 520, 525

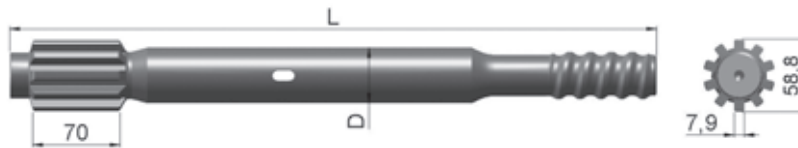

Flushing	Thread	Length L	Diameter D	Product number	Weight
[mm]		[mm]	[mm]		[kg]
-	C38	525	45	06F-07-5753	5,7
-	C45	525	45	3000023	5,8
-	C38	600	45	06F-07-0901	6,2
-	C38	745	45	06F-07-0835	7,7

HL 600, 600S



-	C38	525	45	06F-07-2797	5,7
-	C38	600	45	06F-07-2798	6,2
-	C45	600	45	06F-07-2799	6,3

HL 600, 600S



-	C45	650	52	06F-07-2801	6,4
-	C51	650	52	06F-07-2802	6,4

HL 650, 700, 800T

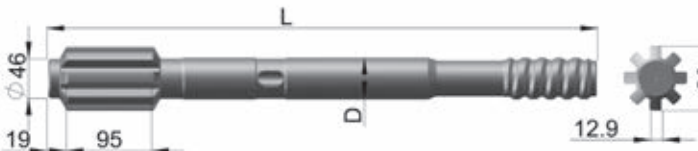

-	C38	600	45	06F-07-2805	7,0
-	C45	600	45	06F-07-2806	7,5

SHANK ADAPTERS for drifters of SANDVIK

RD
HL

HL 650, 700, 800T

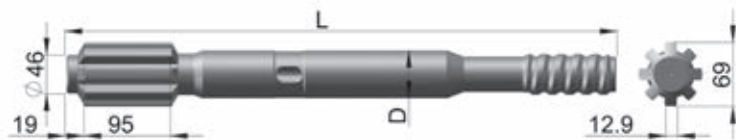

Flushing	Thread	Length L	Diameter D	Product number	Weight
[mm]		[mm]	[mm]		[kg]
-	C38	600	52	06F-07-0482	8,0
-	C45	600	52	06F-07-2182	8,5
-	C51	600	52	06F-07-2331	8,6

RD 900PE

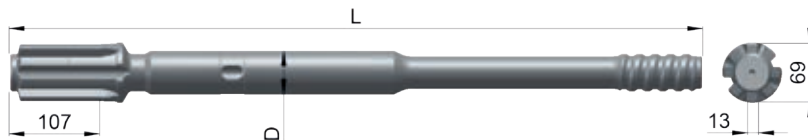

-	C45	820	52	3000244	10,7
-	C51	820	52	3000249	11,4

RD 900PE

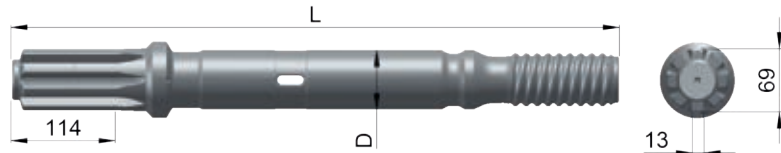

-	CT58	670	65	3000211	14,2
---	------	-----	----	---------	------

HL 1000, 1000S, 1010, 1010S

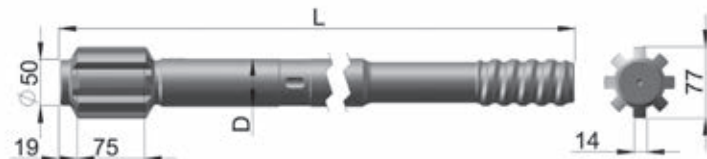

-	C51	590	52	06F-07-2813	9,3
-	C45	670	52	06F-07-2812	10,0
-	C51	670	52	06F-07-2814	10,7

HL

SHANK ADAPTERS for drifters of SANDVIK

HL 1000, 1010

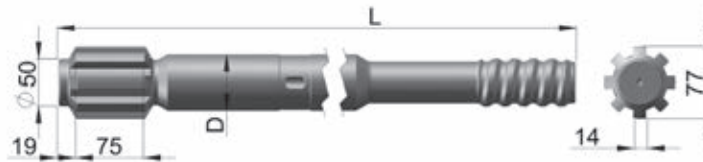

HL 1000 PE, 1010 PE, 1060T, 1060T PE, 1560T, 1560T PE

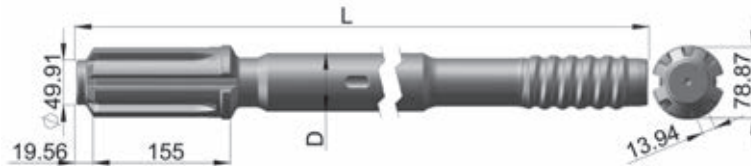

HL 1060T, 1500T, 1560T

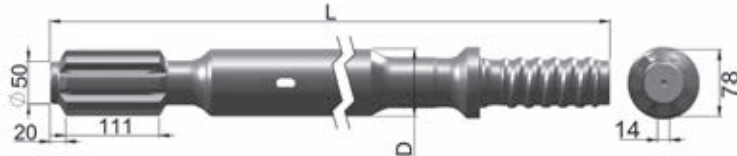

HL 1500, 1500T

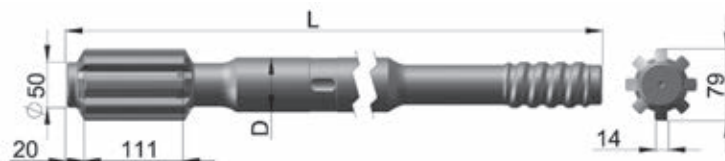

Flushing	Thread	Length L	Diameter D	Product number	Weight
[mm]		[mm]	[mm]		[kg]

-	C51	670	60	06F-07-2815	12,5
-	RG60	670	60	06F-07-3360	12,9

-	C51	760	65	06F-07-3186	15,9
-	RG60	760	65	06F-07-3232	16,9

-	RG60	760	80	06F-07-5460	21,0
---	------	-----	----	-------------	------

-	C51	760	60	06F-07-3363	13,3
-	RG60	760	60	06F-07-3364	14,7

SHANK ADAPTERS for drifters of SANDVIK

HL

HL1500

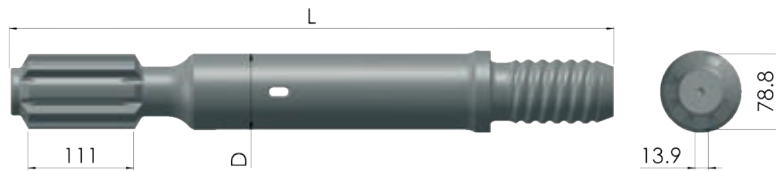

Flushing	Thread	Length L	Diameter D	Product number	Weight
[mm]		[mm]	[mm]		[kg]

-	CT68	635	80	3000006	18,4
---	------	-----	----	---------	------

HL1500T PE-90

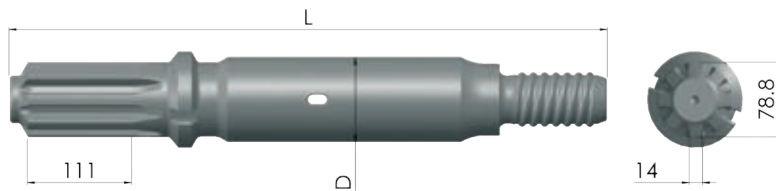

-	CT58	635	90	3000209	21,9
-	CT68	635	90	2000528	22,7

AUXILIARY TOOLS



AUXILIARY TOOLS

Button bit adapters - Couplings



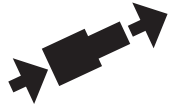

AUXILIARY TOOLS - BUTTON BIT ADAPTERS

Button bit adapters

Order code	Female thread	Male thread	Length L [mm]	Diameter D [mm]	Product number	Weight [kg]
R-series						
R25 F-R28 M	R25	R28	173	45	06E-07-3405	1,1
R25 F-R32 M	R25	R32	173	45	06E-07-3406	1,2
R28 F-R32 M	R28	R32	165	44	06E-07-3407	1,5
R32 F-R38 M	R32	R38	225	45	06E-07-2869	1,8
R32 F-C38 M	R32	C38	225	45	06E-07-2870	1,9
R38 F-R32 M	R38	R32	245	55	06E-07-2871	2,2
R38 F-C38 M	R38	C38	245	55	06E-07-2872	2,4
C-series						
C38 F-R32 M	C38	R32	247	57	06E-07-0499	2,2
C38 F-R38 M	C38	R38	280	57	06E-07-2873	2,7
C38 F-C45 M	C38	C45	285	57	06E-07-2311	2,9
C45 F-C38 M	C45	C38	265	63	06E-07-0838	2,9
C45 F-C51 M	C45	C51	285	63	06E-07-2874	3,6
C51 F-C45 M	C51	C45	285	71	06E-07-2875	4,0





Coupling adapters

Order code	Thread A	Thread B	Length L [mm]	Diameter D [mm]	Bridge	Product number	Weight [kg]
Coupling R32-R25	R32	R25	160	44	F	06E-07-2857	1,2
Coupling R32-R28	R32	R28	160	44	F	06E-07-3387	1,2
Coupling R38-R32	R38	R32	180	55	F	06E-07-2660	1,7
Coupling C38-R32	C38	R32	190	55	F	06E-07-2863	1,7
Coupling C38-R38	C38	R38	190	55	F	06E-07-2865	1,9
Coupling C45-C38	C45	C38	206	63	F	06E-07-3388	3,0
Coupling C51-C45	C51	C45	225	72	F	06E-07-3389	3,8

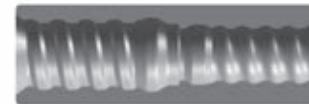
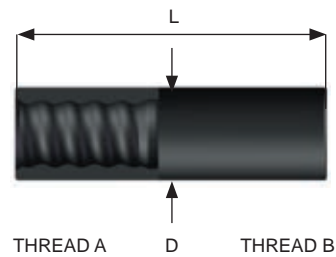



AUXILIARY TOOLS - COUPLINGS

Coupling sleeve

Order code	Thread A	Thread B	Length L [mm]	Diameter D [mm]	Bridge	Product number	Weight [kg]
Coupling R25	R25	R25	150	35	S	06E-07-2856	0,7
Coupling R32	R32	R32	150	44	S	06E-07-0496	1,0
Coupling R38	R38	R38	170	55	S	06E-07-0495	1,9
Coupling C38	C38	C38	190	55	S	06E-07-0497	2,0
Coupling C45	C45	C45	210	63	S	06E-07-0889	2,8
Coupling C45	C45	C45	210	66	S	06E-07-2854	3,1
Coupling C51	C51	C51	225	72	S	06E-07-2853	3,8
Coupling C51	C51	C51	225	77	S	06E-07-0494	4,7

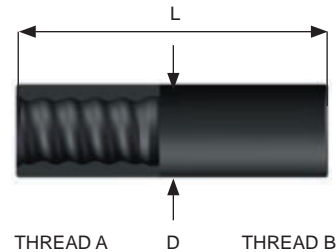

ROBIT PLC
Vikiniityntie 9
FI-33880 LEMPÄÄLÄ (TAMPERE)
FINLAND

Tel: +358 3 3140 3400
E-mail: sales@robitgroup.com
<https://www.robitgroup.com>

Your distributor:



Robit reserves all rights to any changes in the products and the specifications without prior notice.
Printed: August 2022 Copyright © 2022 by Robit Plc

Robit – The Competitive Offering in High Quality Drilling Consumables

